

7' Hot Tubs / Option Index

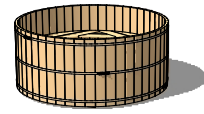

Tub Only

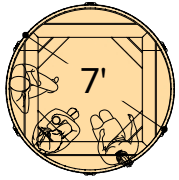
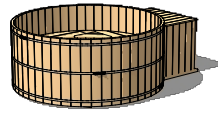

Equipment Box

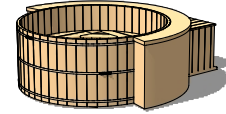

Skirting Kit

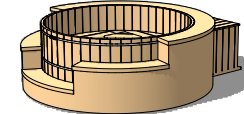

Multi Skirting Kit

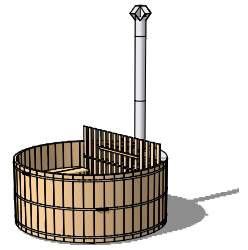

Wood Fired

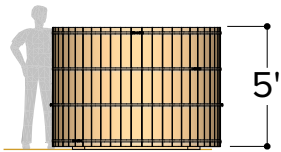
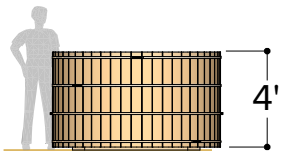
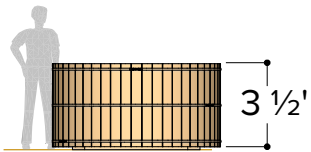
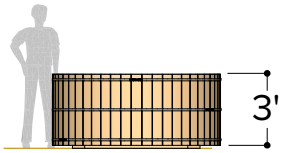

Tub Height

2	3	4	5	6
7	8	9	10	11
12	13	14	15	16
17	18	19	20	

Rectangle Concrete Pad

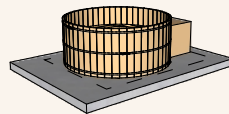

21

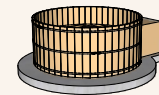

Circular Concrete Pad

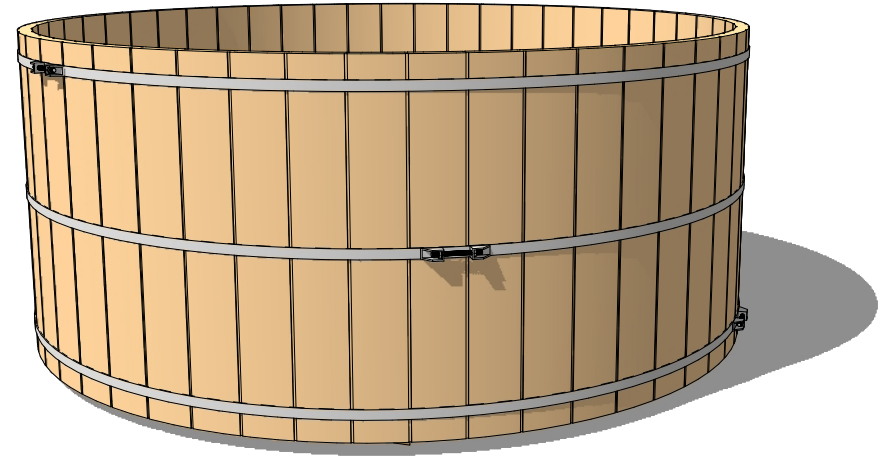
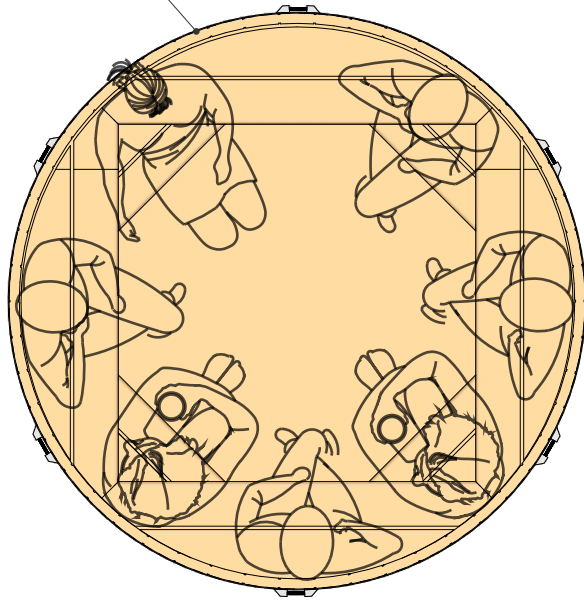

22

ø 84" (7')



Occupancy	Water Capacity <small>(6" gap between top of tub to water level)</small>	Water Weight <small>(6" gap between top of tub to water level) (water weight calculated at 50°F / 10.0°C)</small>
Typical:  7	2194 Litres	2194 Kilograms
Max:  8	580 Gallons	4836 Pounds

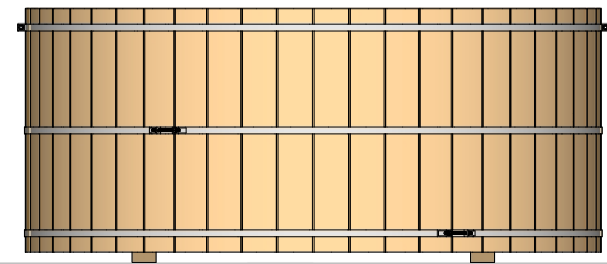
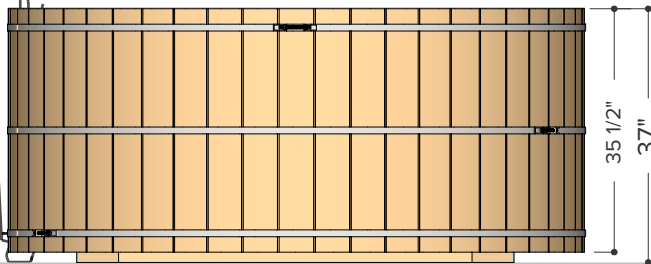
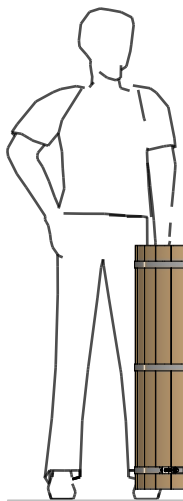

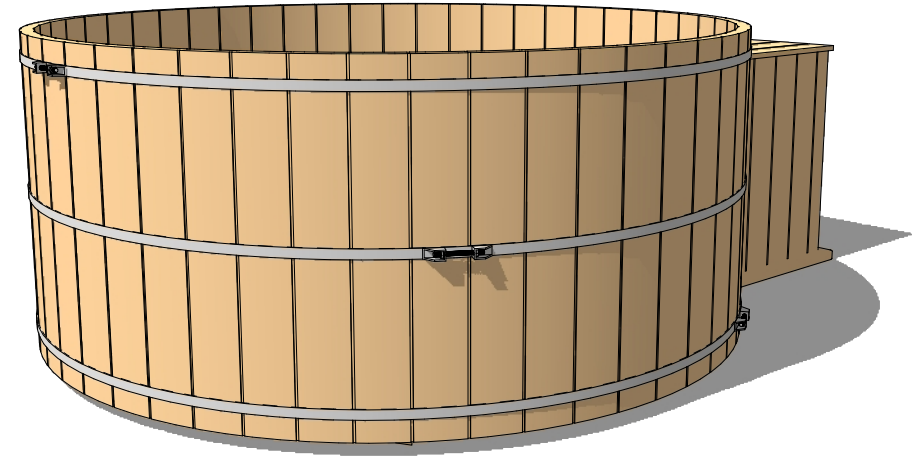
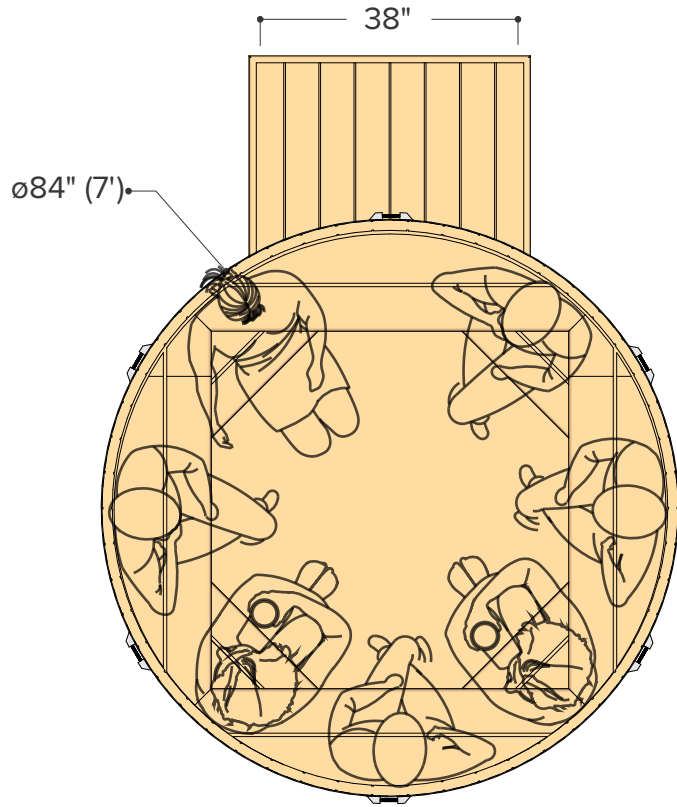

Occupancy	Water Capacity <small>(6" gap between top of tub to water level)</small>	Water Weight <small>(6" gap between top of tub to water level) (water weight calculated at 50°F / 10.0°C)</small>
Typical: 7	2194 Litres	2194 Kilograms
Max: 8	580 Gallons	4836 Pounds

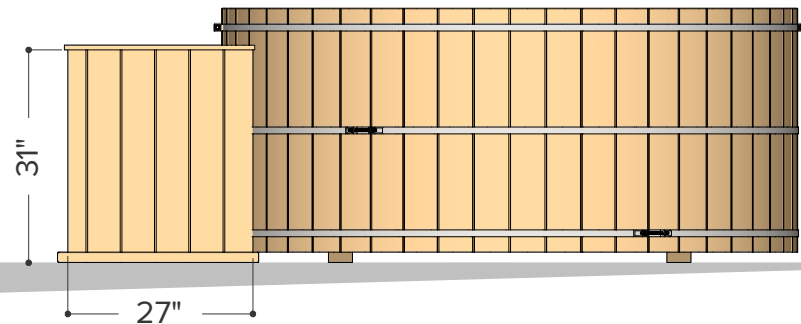
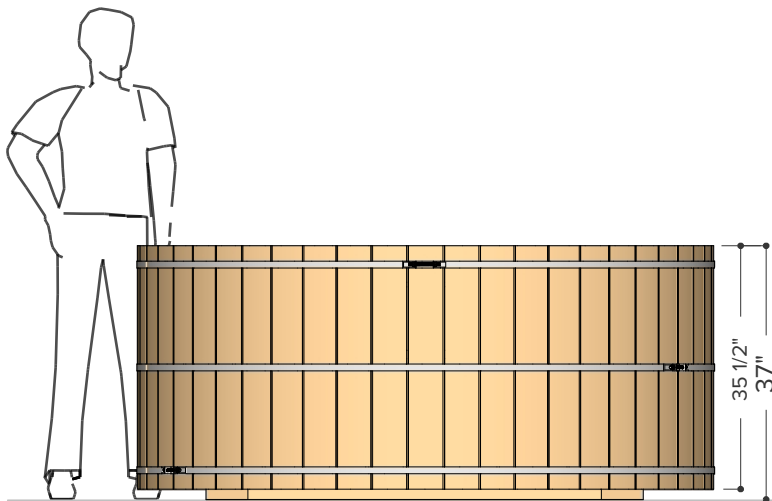

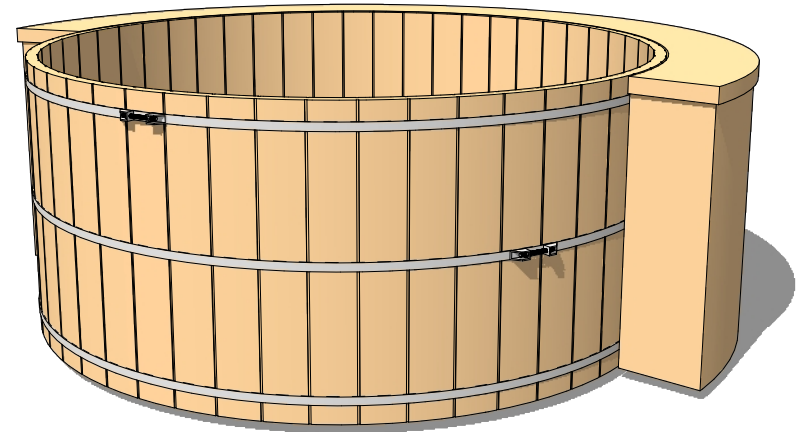
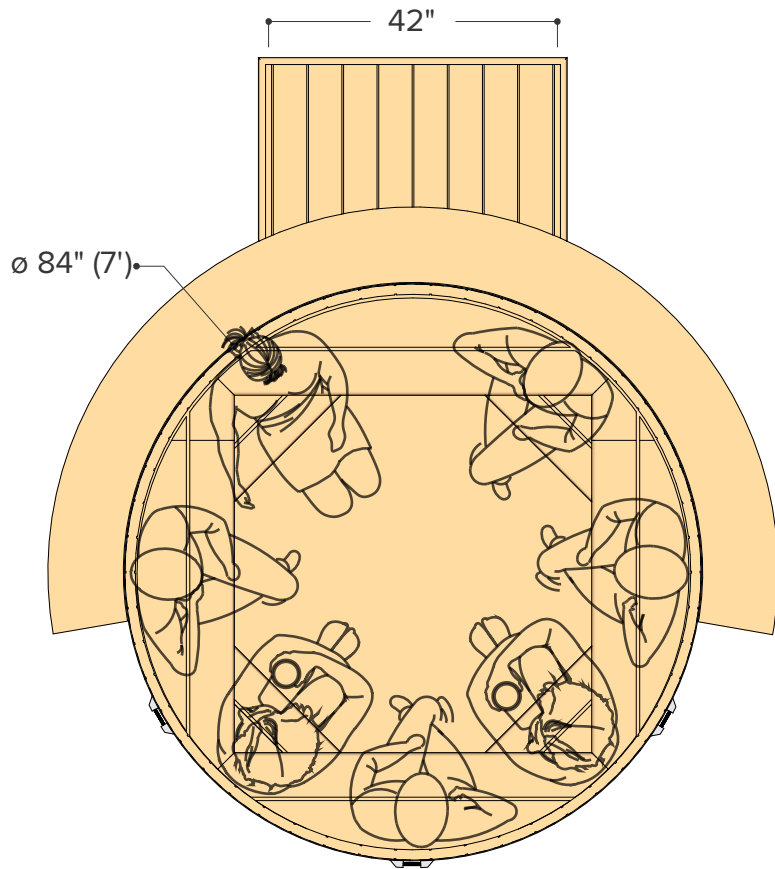

Occupancy	Water Capacity <small>(6" gap between top of tub to water level)</small>	Water Weight <small>(6" gap between top of tub to water level) (water weight calculated at 50°F / 10.0°C)</small>
Typical: 7	2194 Litres	2194 Kilograms
Max: 8	580 Gallons	4836 Pounds

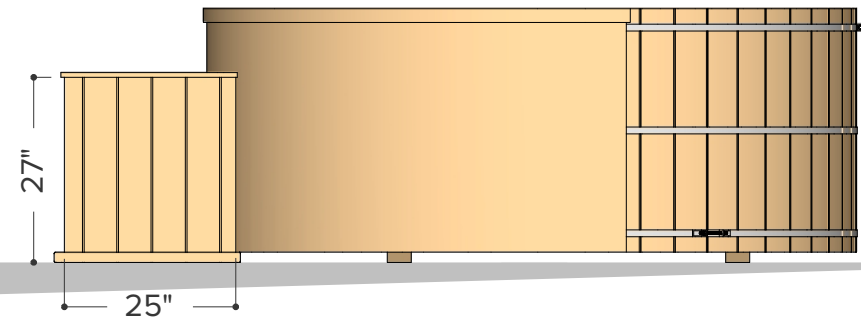
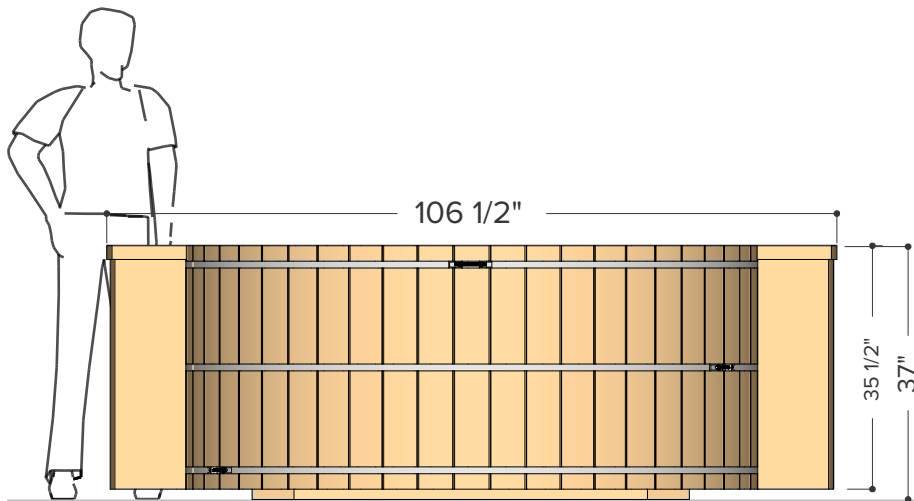

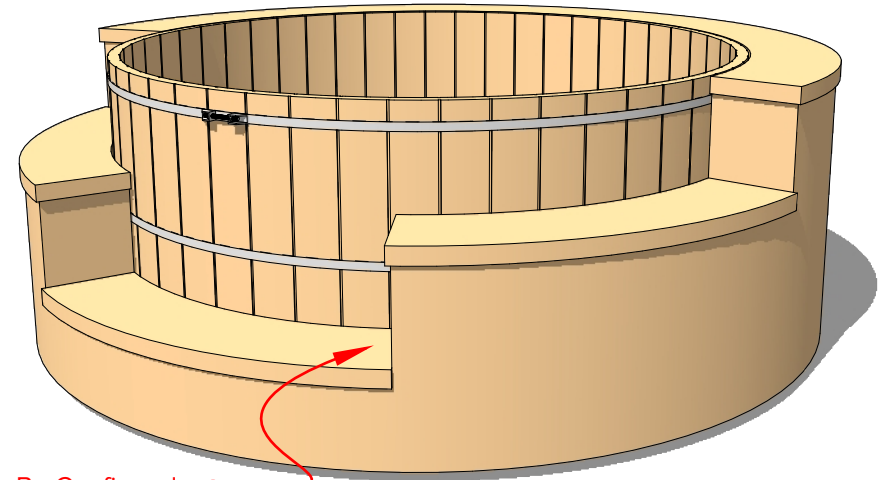
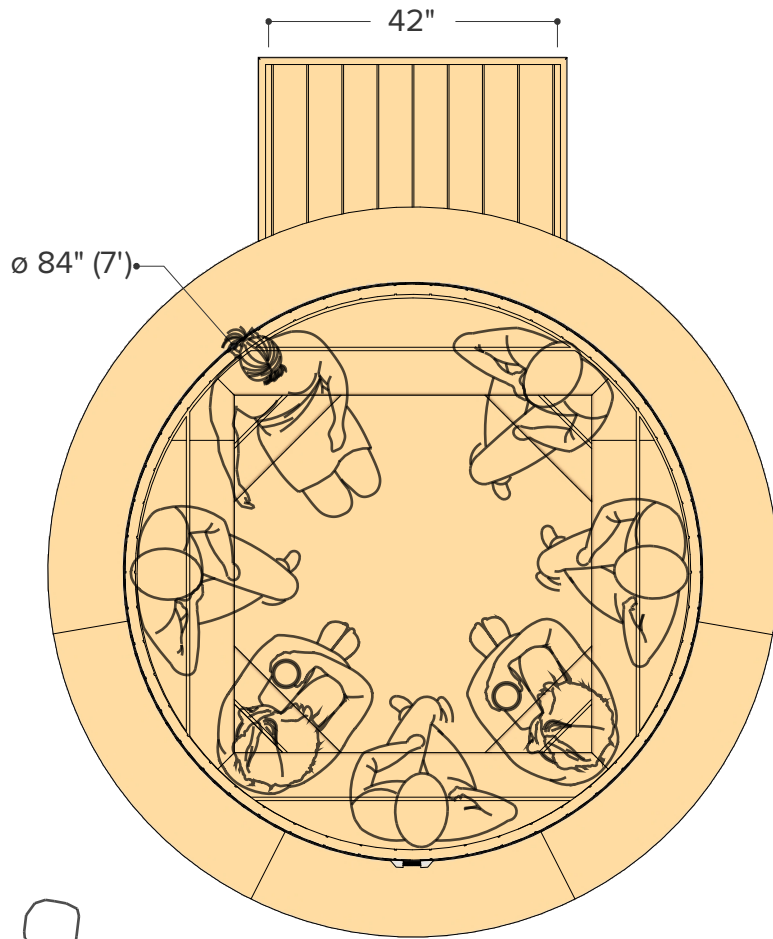

Step Designs To Be Confirmed
Please contact sales department
for further information

Occupancy	Water Capacity <small>(6" gap between top of tub to water level)</small>	Water Weight <small>(6" gap between top of tub to water level) (water weight calculated at 50°F / 10.0°C)</small>
Typical: 🧑 7	2194 Litres	2194 Kilograms
Max: 🧑 8	580 Gallons	4836 Pounds

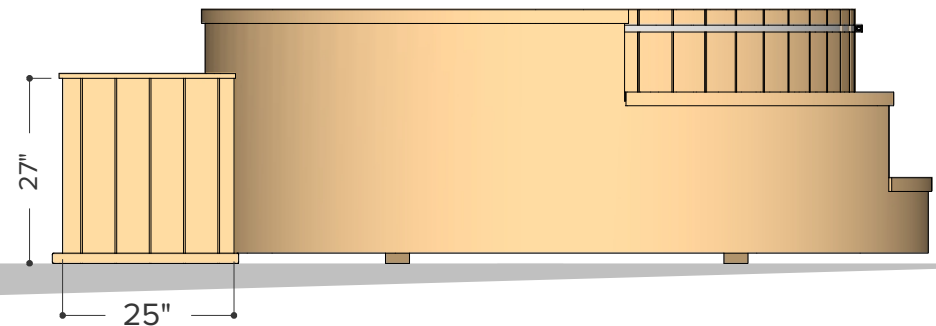
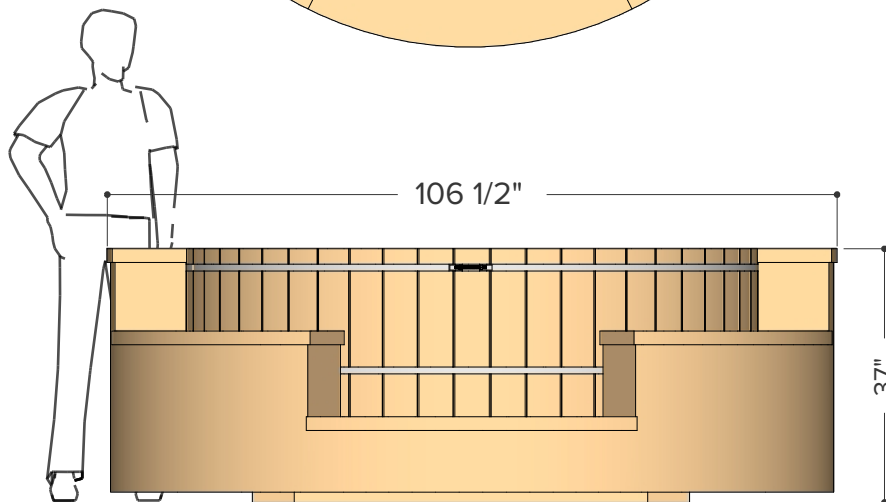

ø 84" (7')

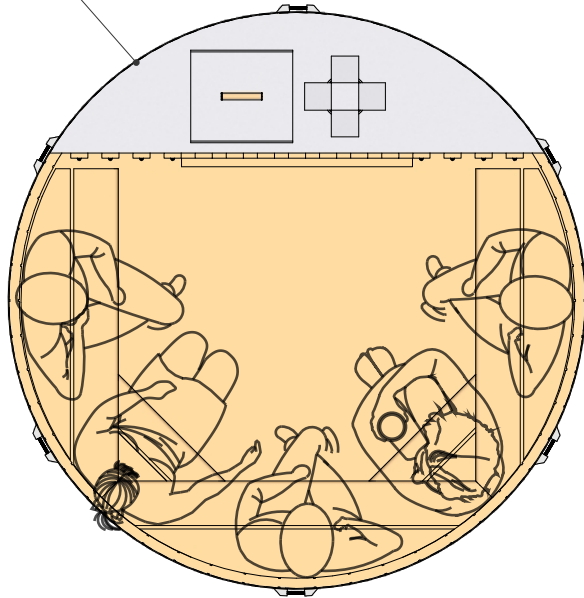

Occupancy	Water Capacity <small>(6" gap between top of tub to water level)</small>	Water Weight <small>(6" gap between top of tub to water level) (water weight calculated at 50°F / 10.0°C)</small>
Typical: 5	2194 Litres	2194 Kilograms
Max: 6	580 Gallons	4836 Pounds

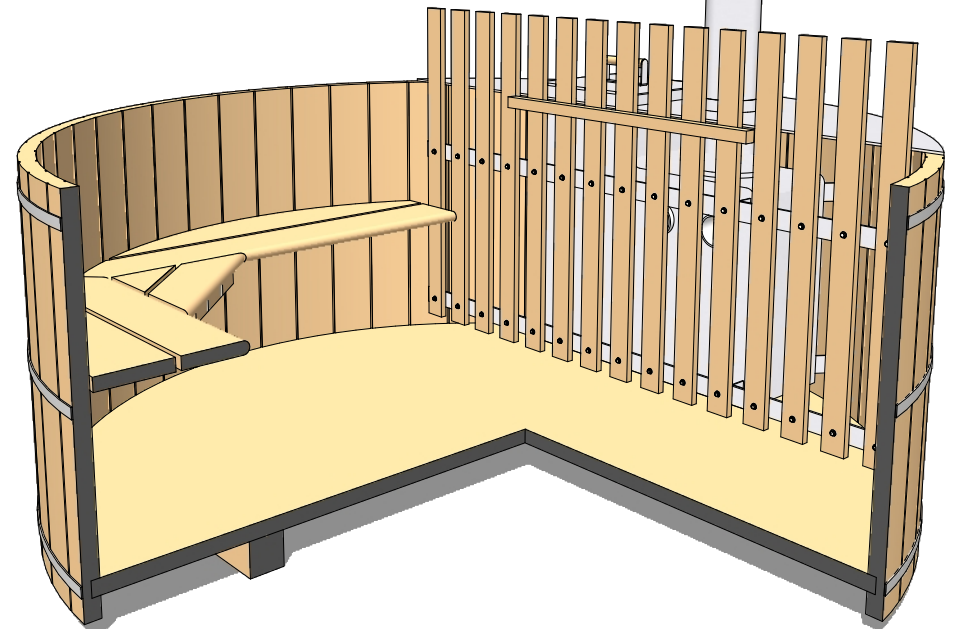
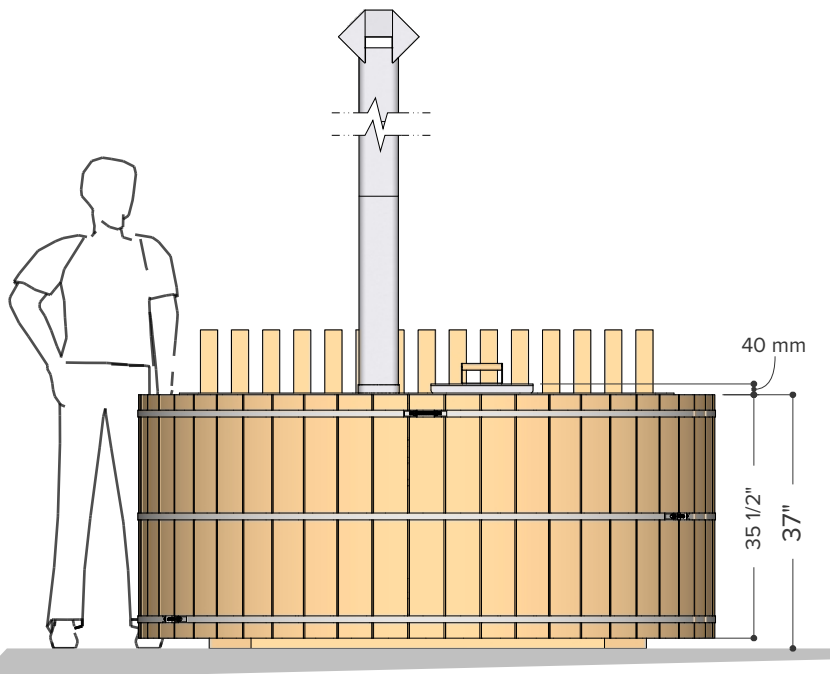
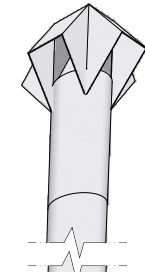

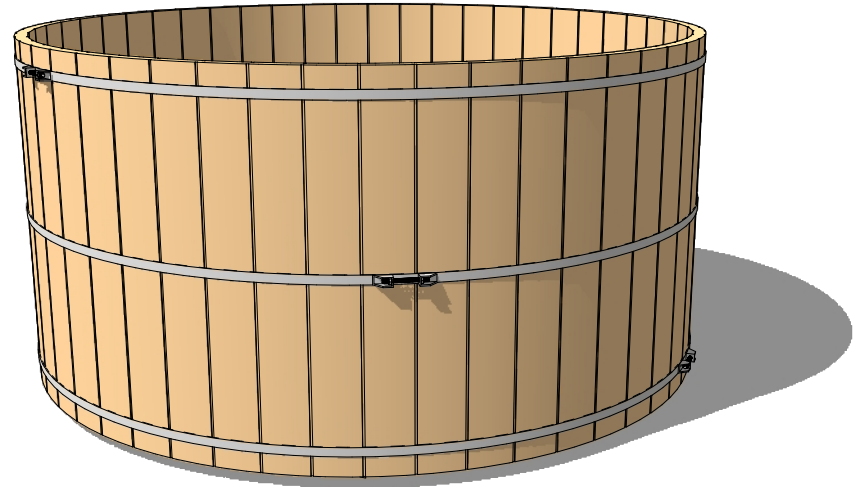
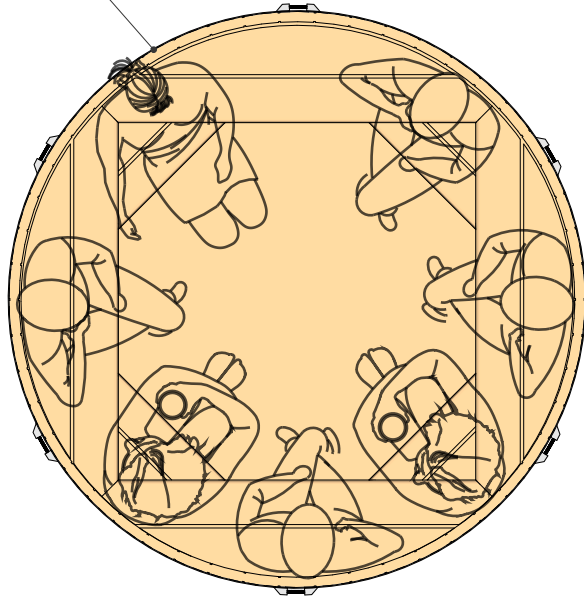

ø 84" (7')

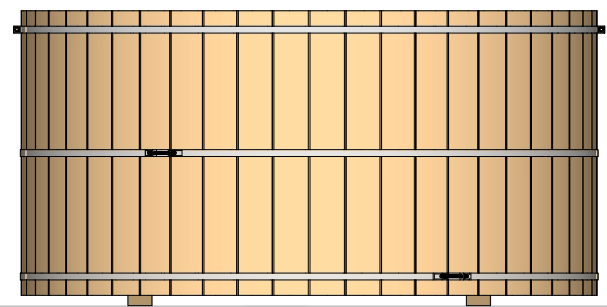
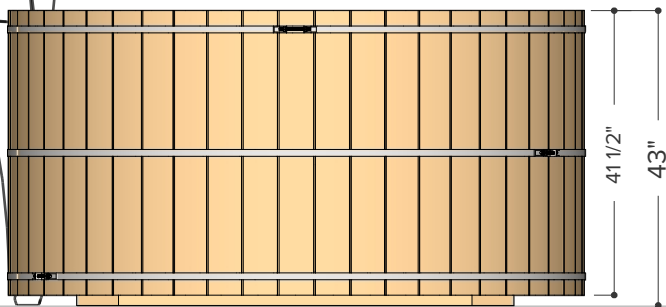
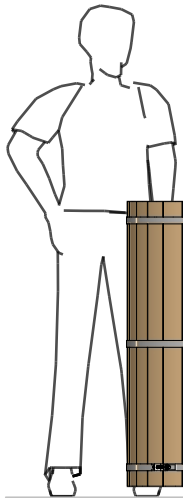

Occupancy	Water Capacity <small>(6" gap between top of tub to water level)</small>	Water Weight <small>(6" gap between top of tub to water level) (water weight calculated at 50°F / 10.0°C)</small>
Typical: 7	2700 Litres	2700 Kilograms
Max: 8	713 Gallons	5951 Pounds

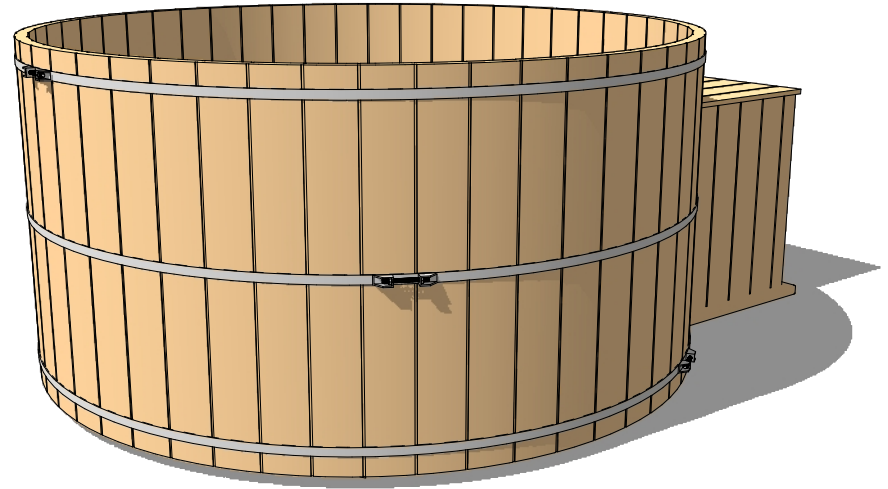
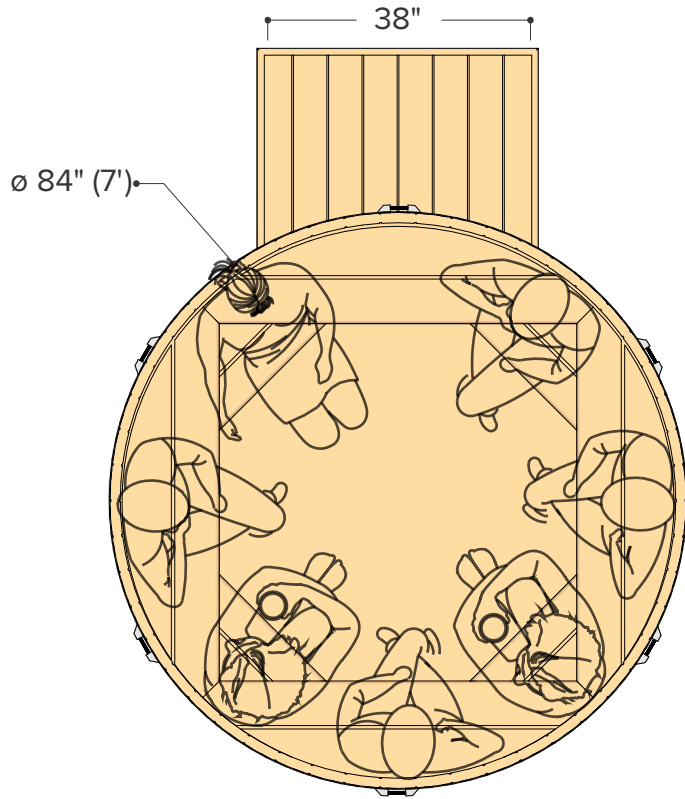



Occupancy	Water Capacity <small>(6" gap between top of tub to water level)</small>	Water Weight <small>(6" gap between top of tub to water level) (water weight calculated at 50°F / 10.0°C)</small>
Typical:  7	2700 Litres	2700 Kilograms
Max:  8	713 Gallons	5951 Pounds

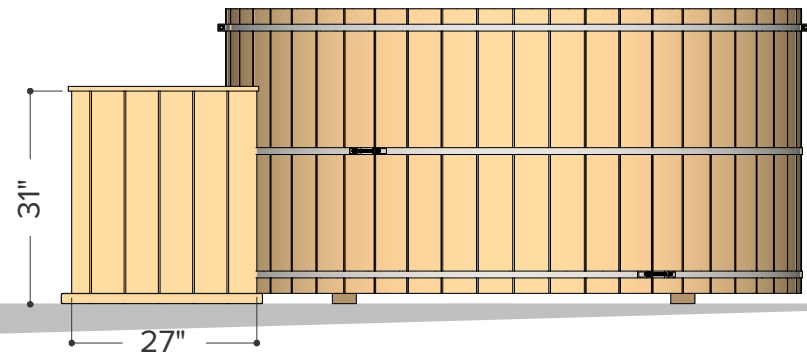
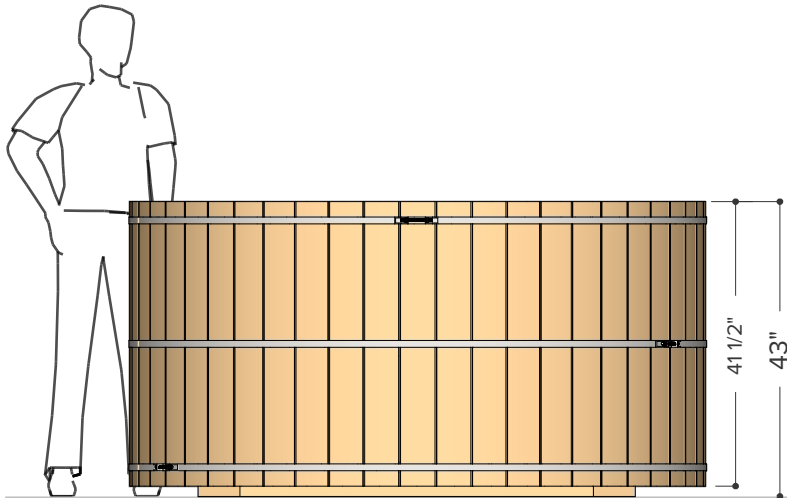

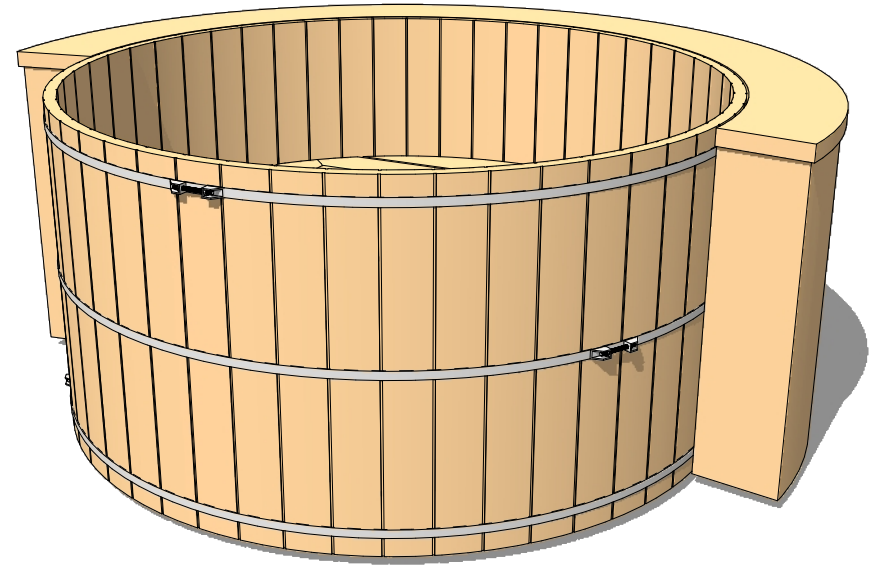
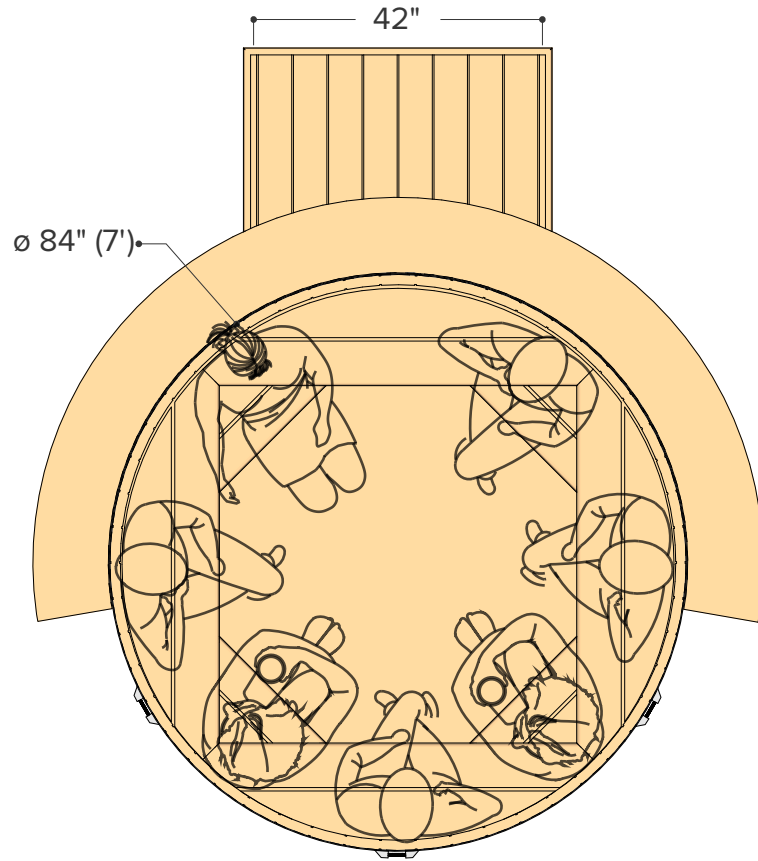

Occupancy	Water Capacity <small>(6" gap between top of tub to water level)</small>	Water Weight <small>(6" gap between top of tub to water level) (water weight calculated at 50°F / 10.0°C)</small>
Typical: 7	2700 Litres	2700 Kilograms
Max: 8	713 Gallons	5951 Pounds

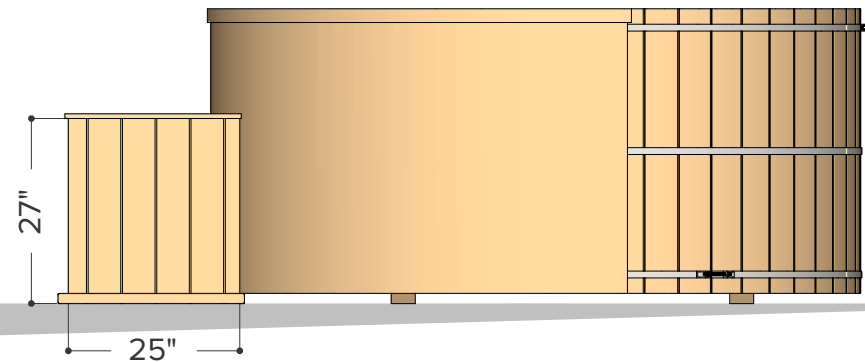
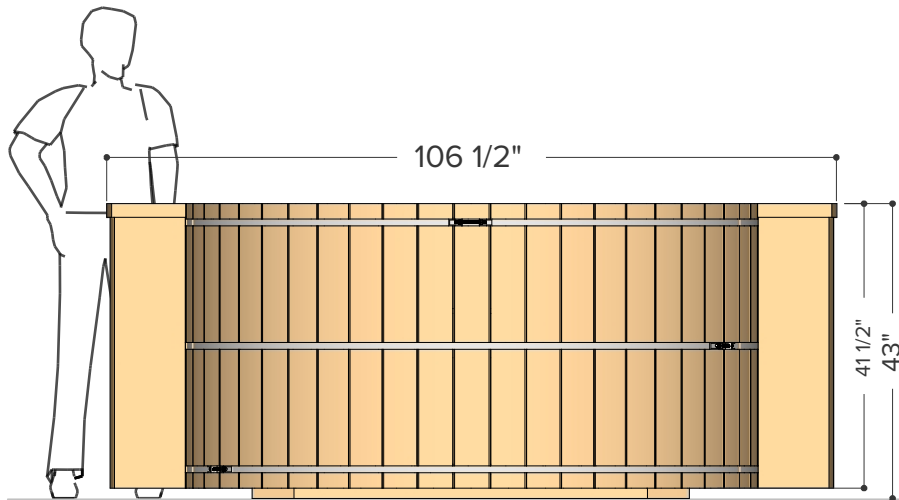

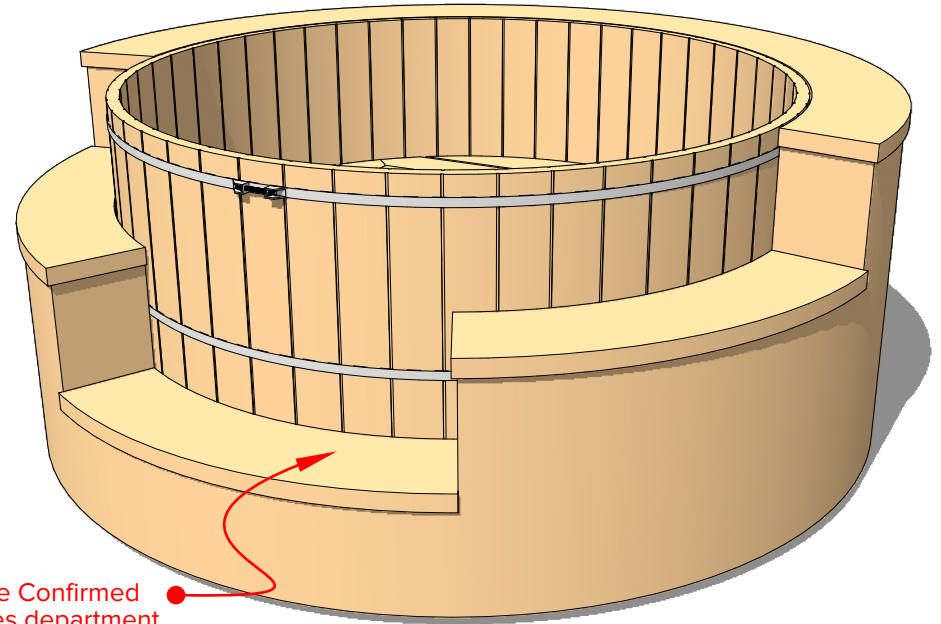
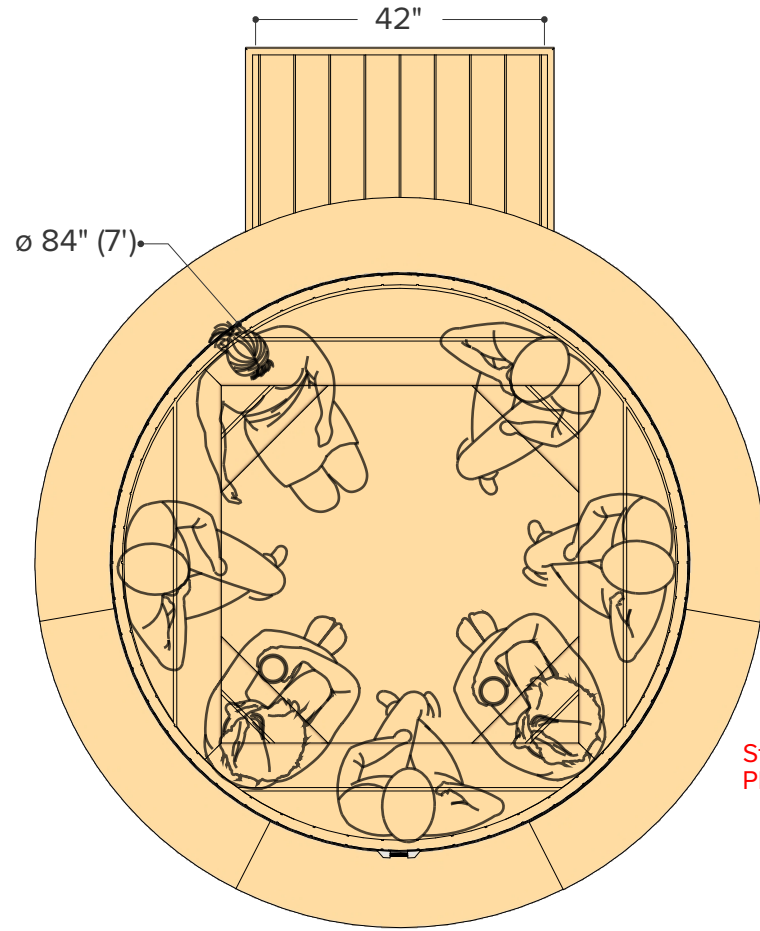

Step Designs To Be Confirmed
Please contact sales department
for further information

Occupancy	Water Capacity <small>(6" gap between top of tub to water level)</small>	Water Weight <small>(6" gap between top of tub to water level) (water weight calculated at 50°F / 10.0°C)</small>
Typical: 7	2700 Litres	2700 Kilograms
Max: 8	713 Gallons	5951 Pounds

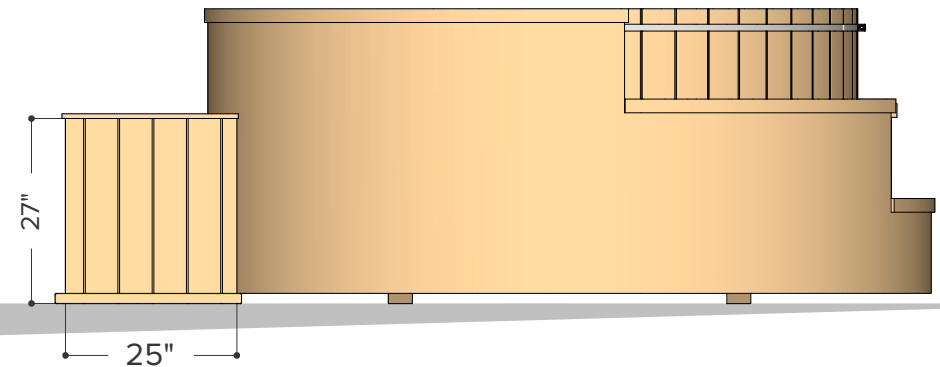
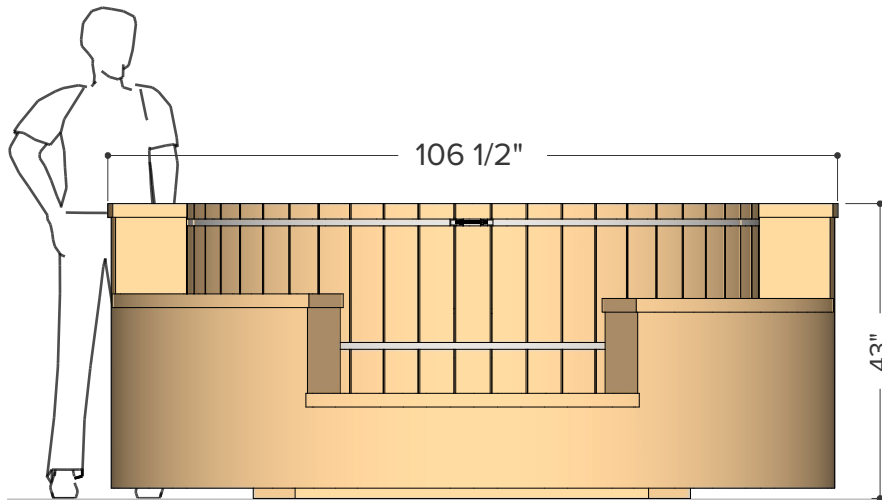

ø 84" (7')

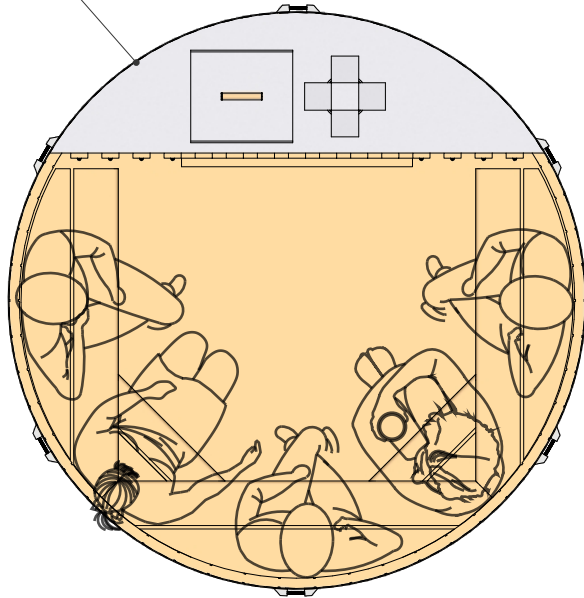

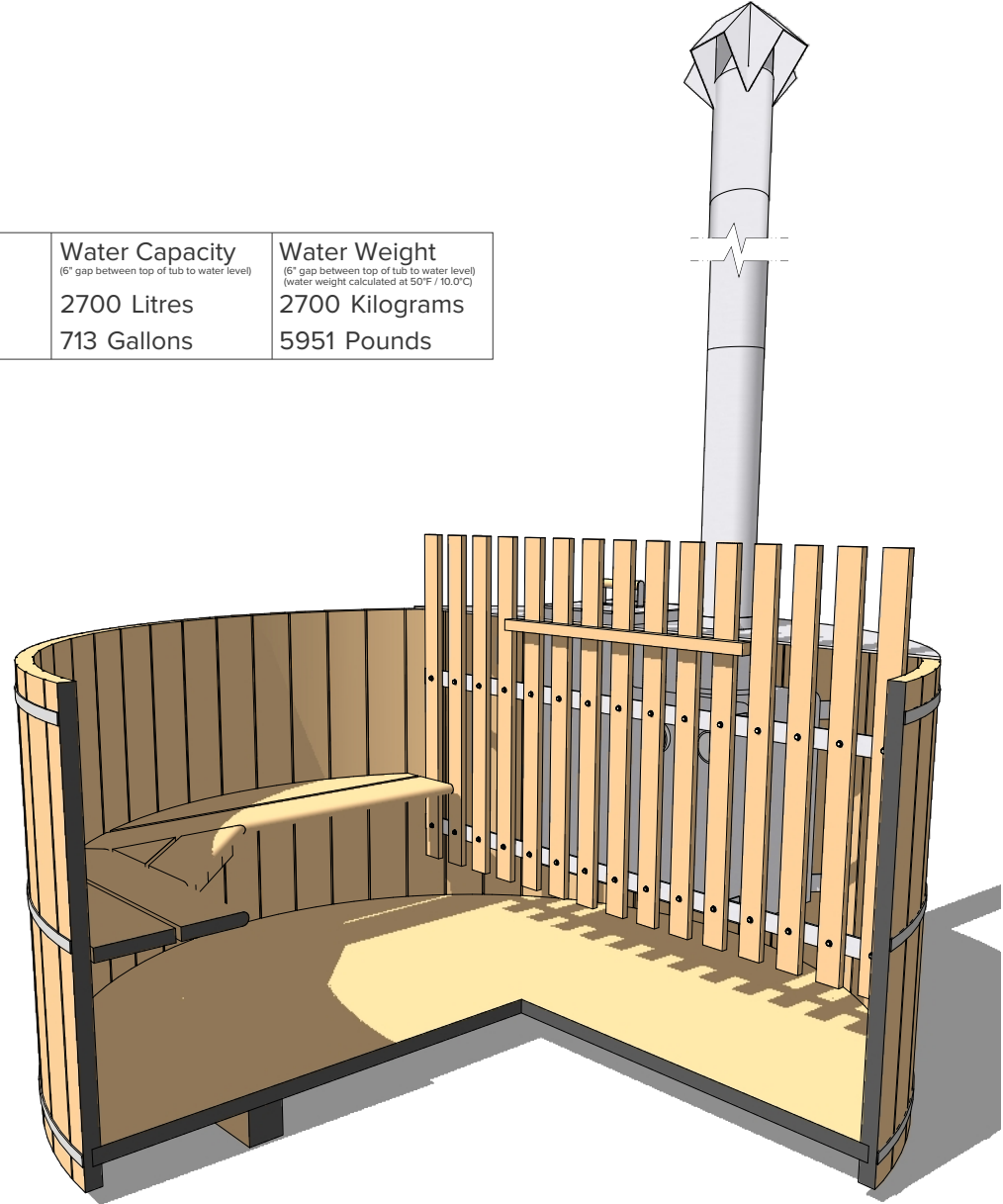
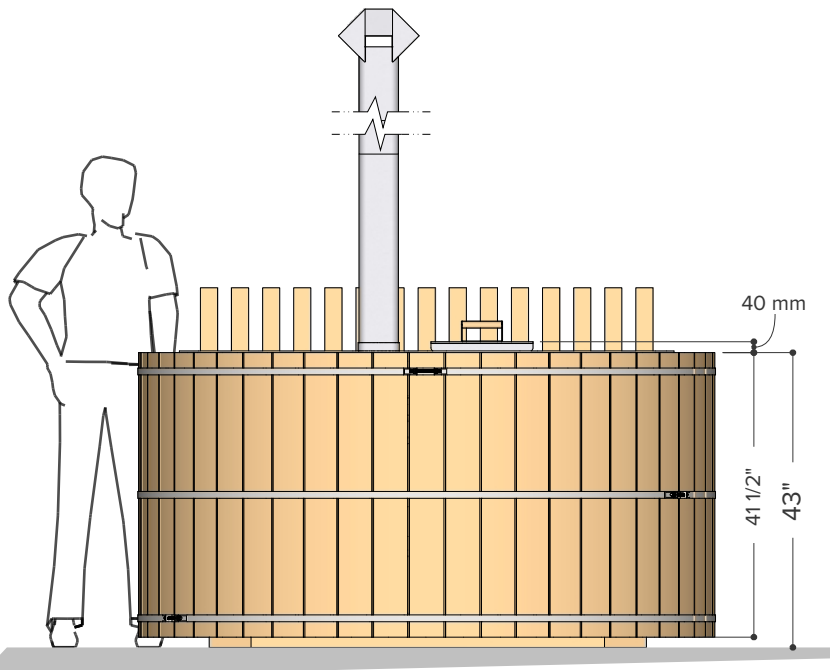

Occupancy	Water Capacity <small>(5" gap between top of tub to water level)</small>	Water Weight <small>(5" gap between top of tub to water level) (water weight calculated at 50°F / 10.0°C)</small>
Typical: 5	2700 Litres	2700 Kilograms
Max: 6	713 Gallons	5951 Pounds

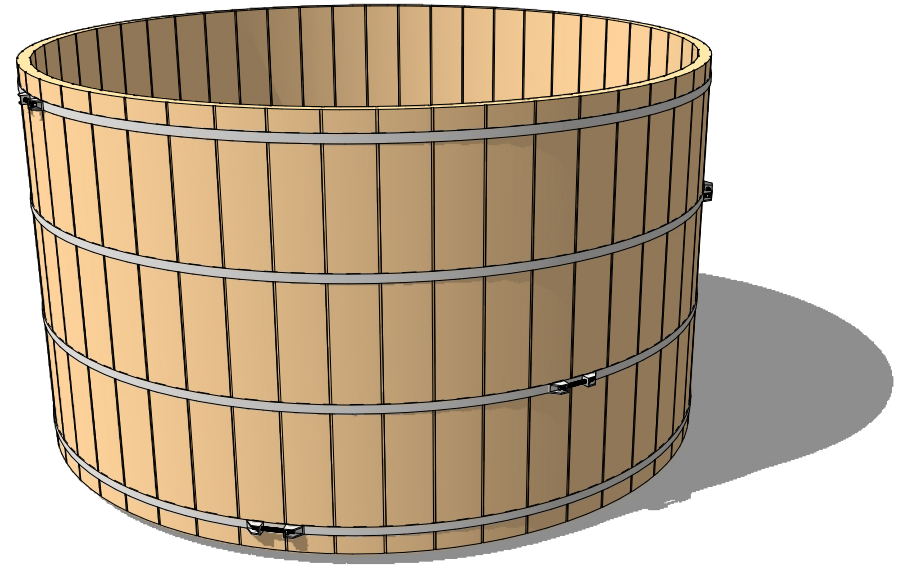
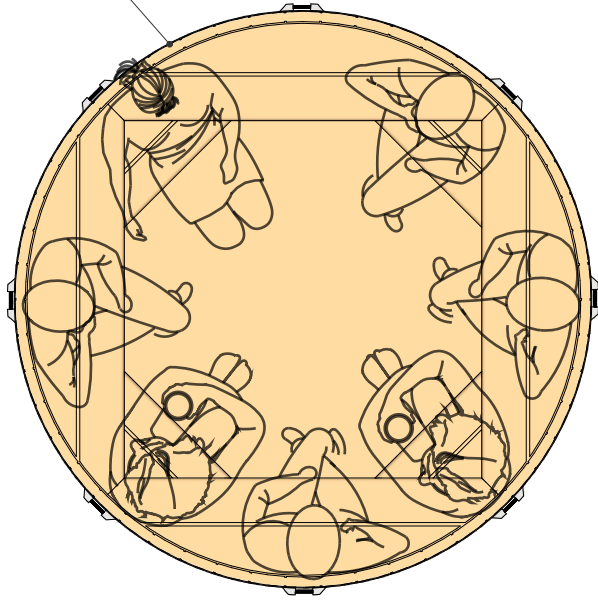

ø 84" (7')



Occupancy	Water Capacity <small>(6" gap between top of tub to water level)</small>	Water Weight <small>(6" gap between top of tub to water level) (water weight calculated at 50°F / 10.0°C)</small>
Typical:  7	3206 Litres	3206 Kilograms
Max:  8	847 Gallons	7066 Pounds

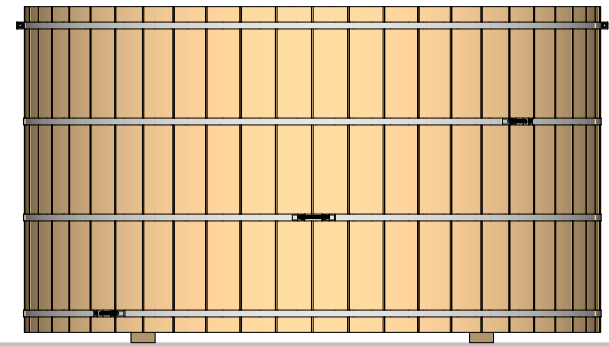
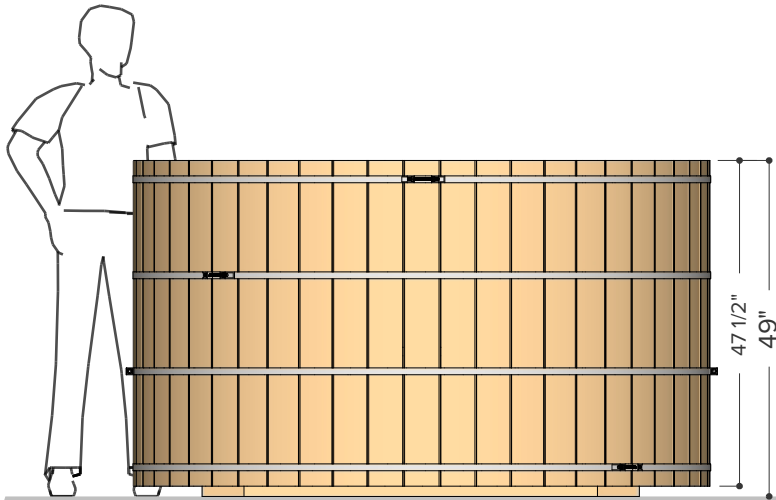

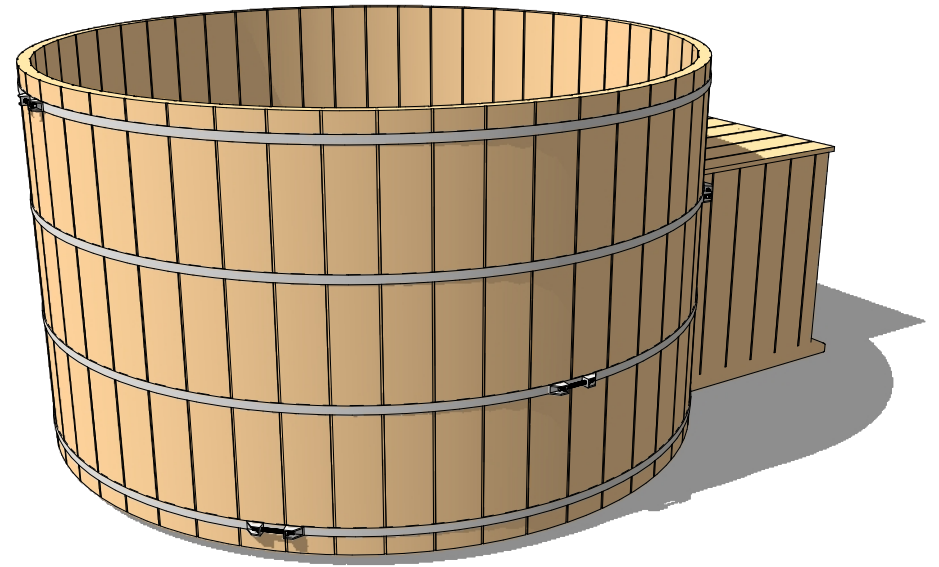
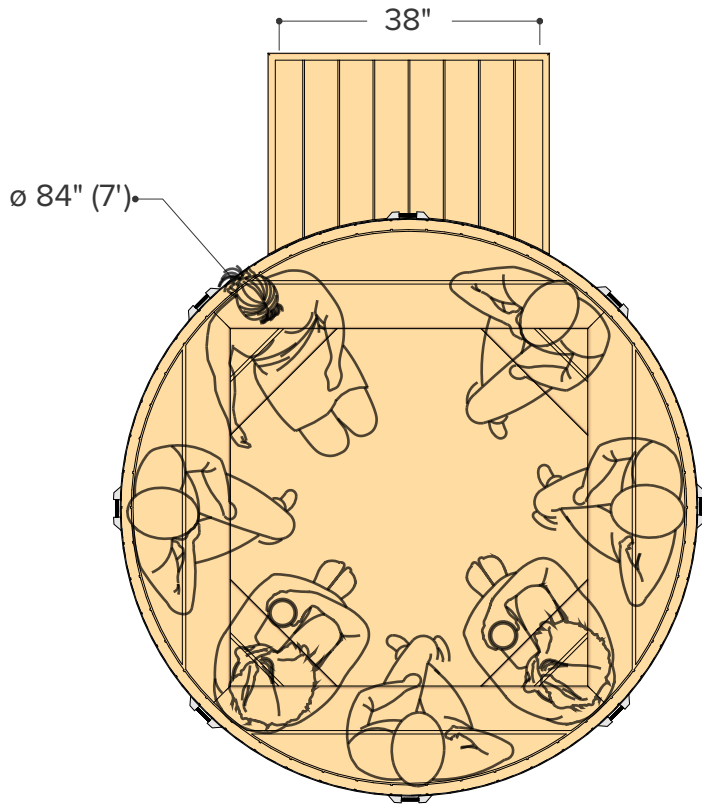

Occupancy	Water Capacity <small>(6" gap between top of tub to water level)</small>	Water Weight <small>(6" gap between top of tub to water level) (water weight calculated at 50°F / 10.0°C)</small>
Typical: 7	3206 Litres	3206 Kilograms
Max: 8	847 Gallons	7066 Pounds

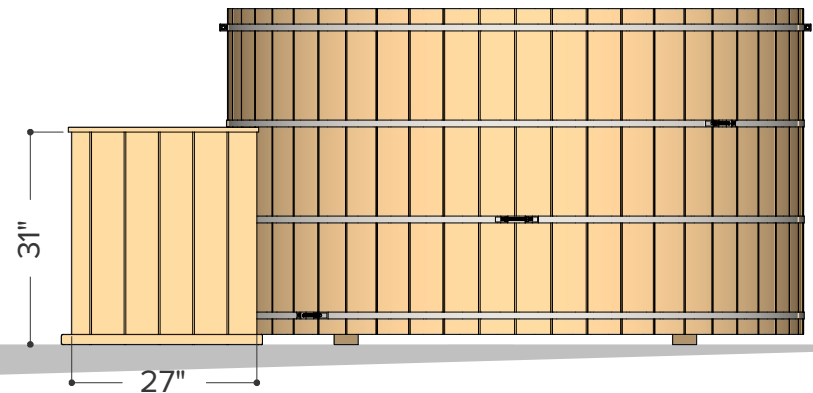
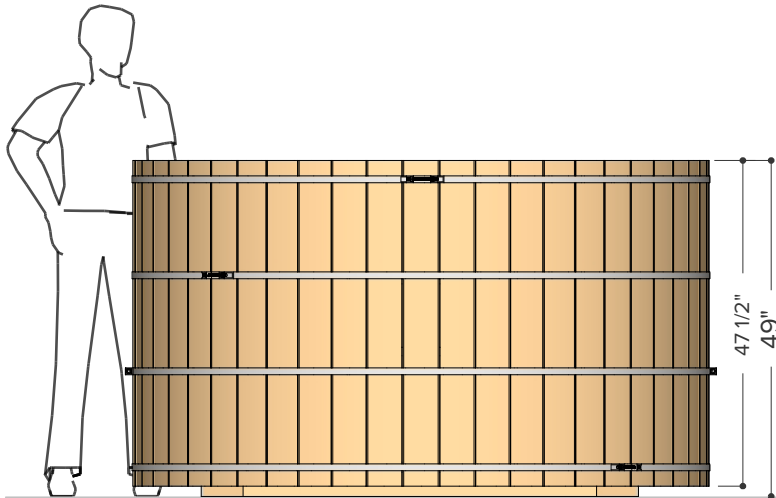

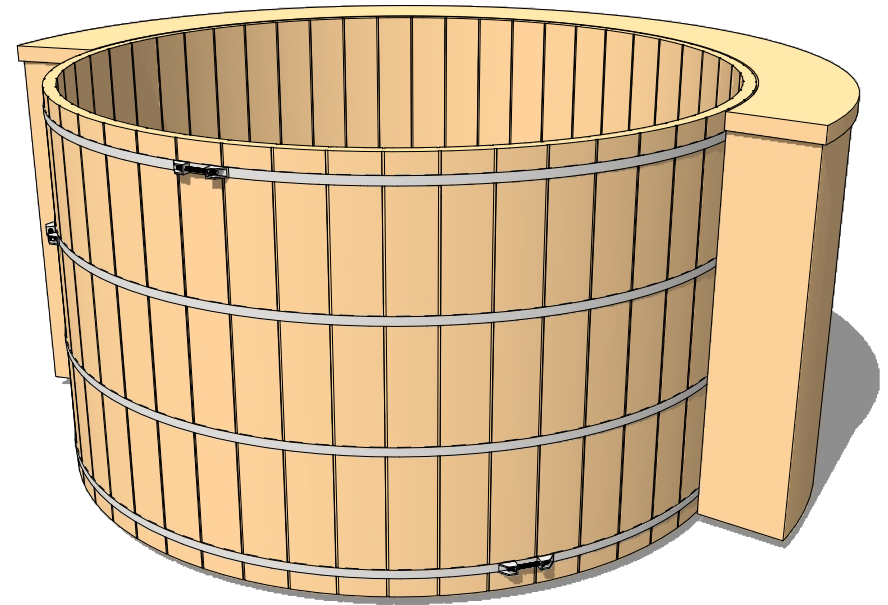
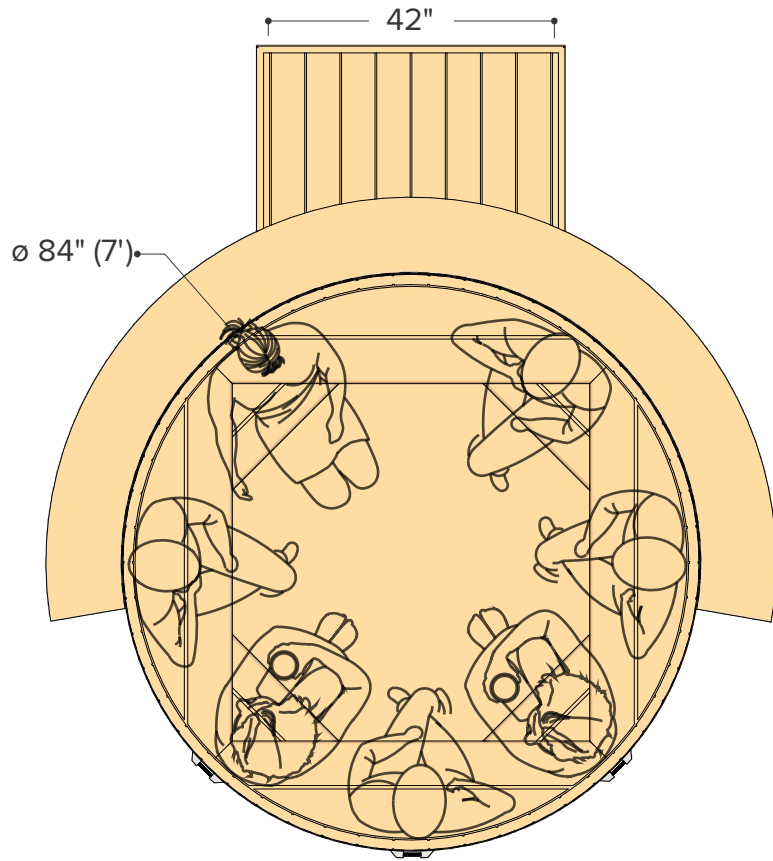

Occupancy	Water Capacity <small>(6" gap between top of tub to water level)</small>	Water Weight <small>(6" gap between top of tub to water level) (water weight calculated at 50°F / 10.0°C)</small>
Typical: 7	3206 Litres	3206 Kilograms
Max: 8	847 Gallons	7066 Pounds

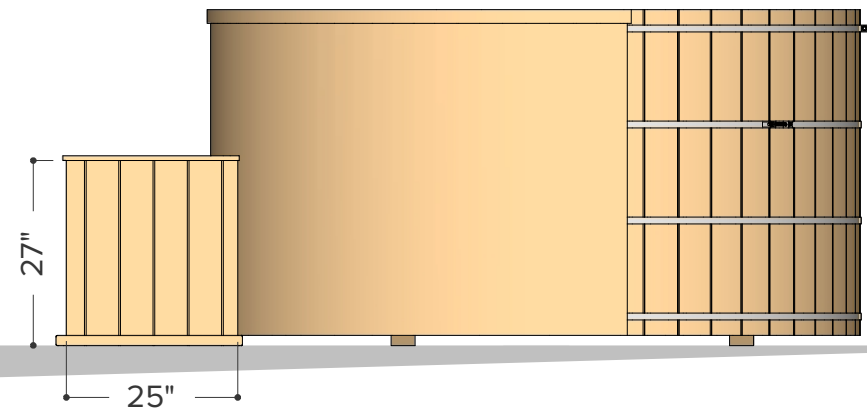
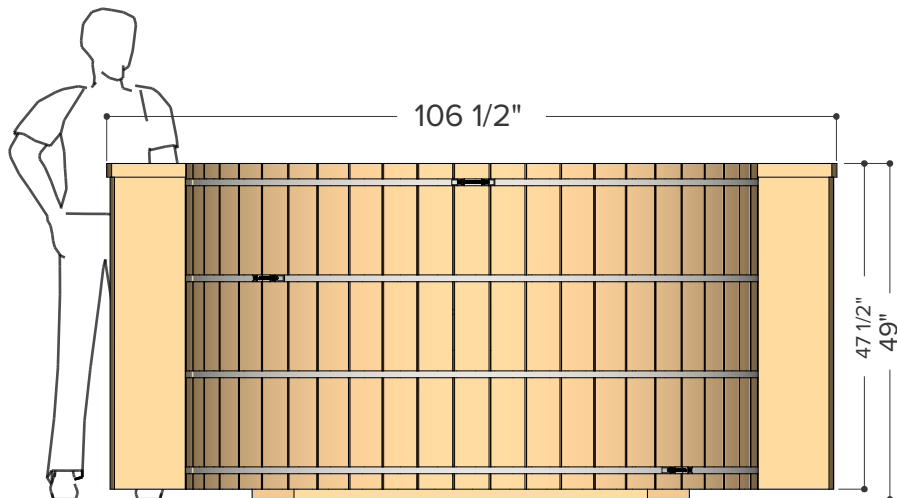

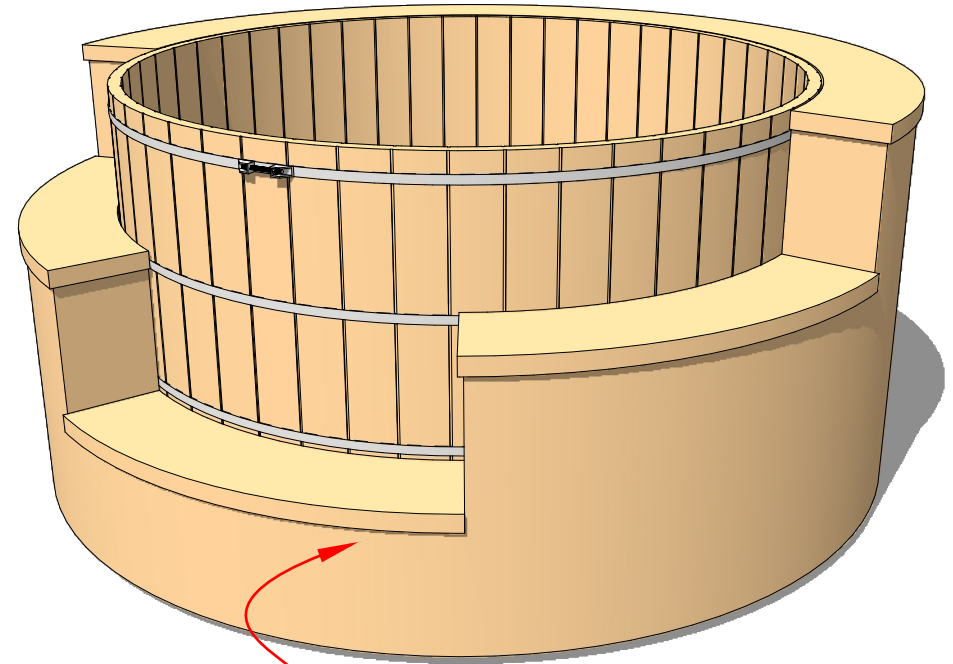
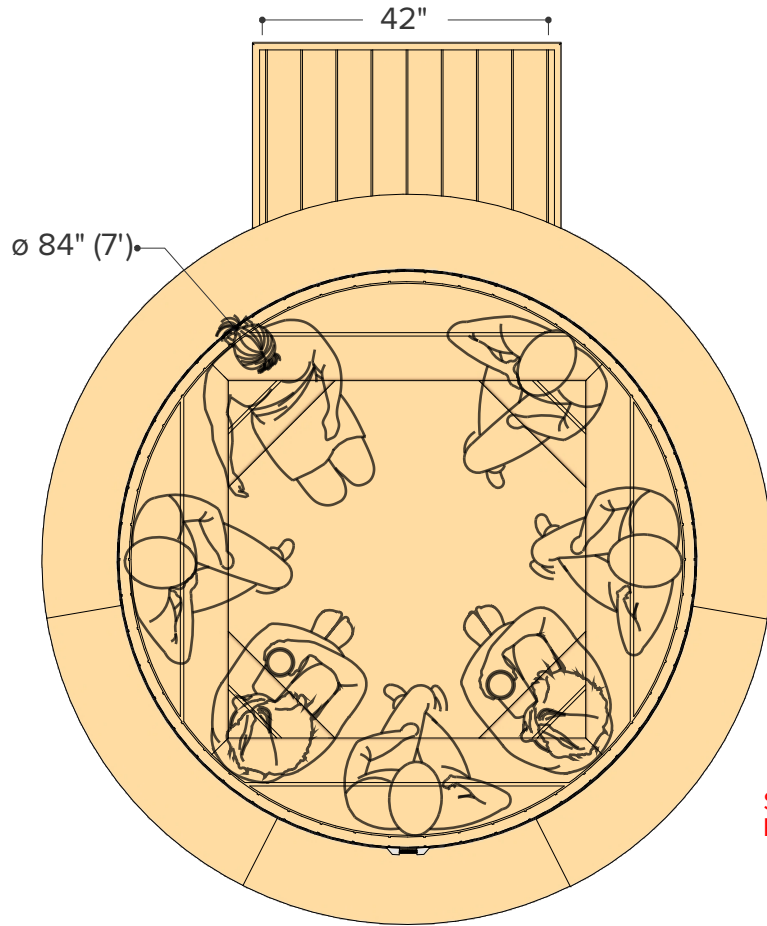

Step Designs To Be Confirmed
Please contact sales department
for further information

Occupancy	Water Capacity <small>(6" gap between top of tub to water level)</small>	Water Weight <small>(6" gap between top of tub to water level) (water weight calculated at 50°F / 10.0°C)</small>
Typical: 7	3206 Litres	3206 Kilograms
Max: 8	847 Gallons	7066 Pounds

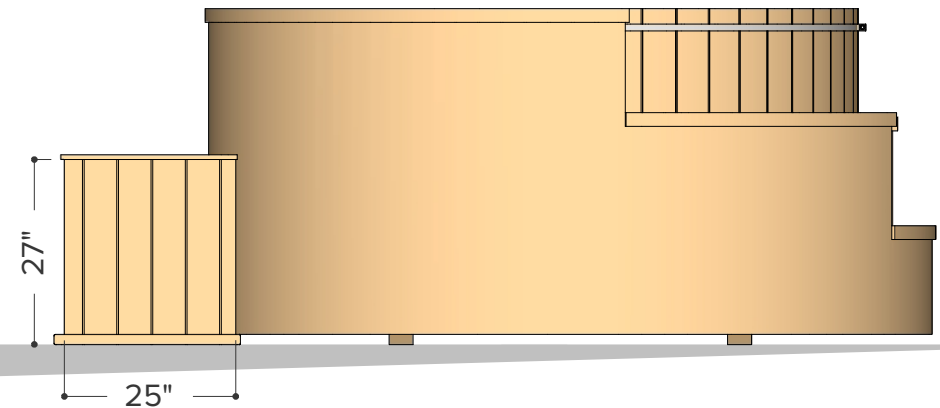
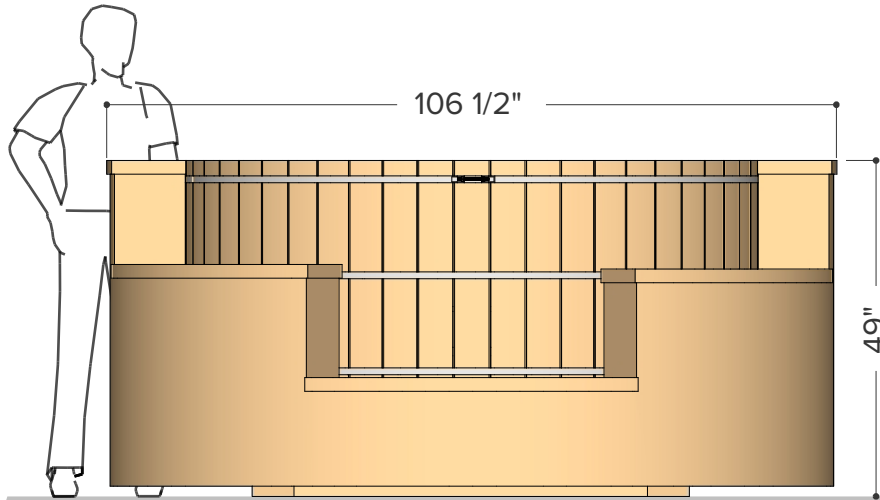

ø 84" (7')

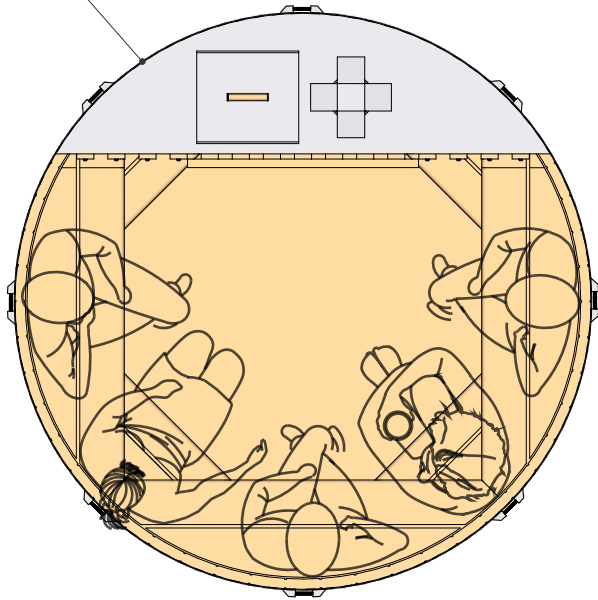

Occupancy

Typical: 5

Max: 6

Water Capacity
(6" gap between top of tub to water level)

3206 Litres

847 Gallons

Water Weight
(6" gap between top of tub to water level)
(water weight calculated at 50°F / 10.0°C)

3206 Kilograms

7066 Pounds

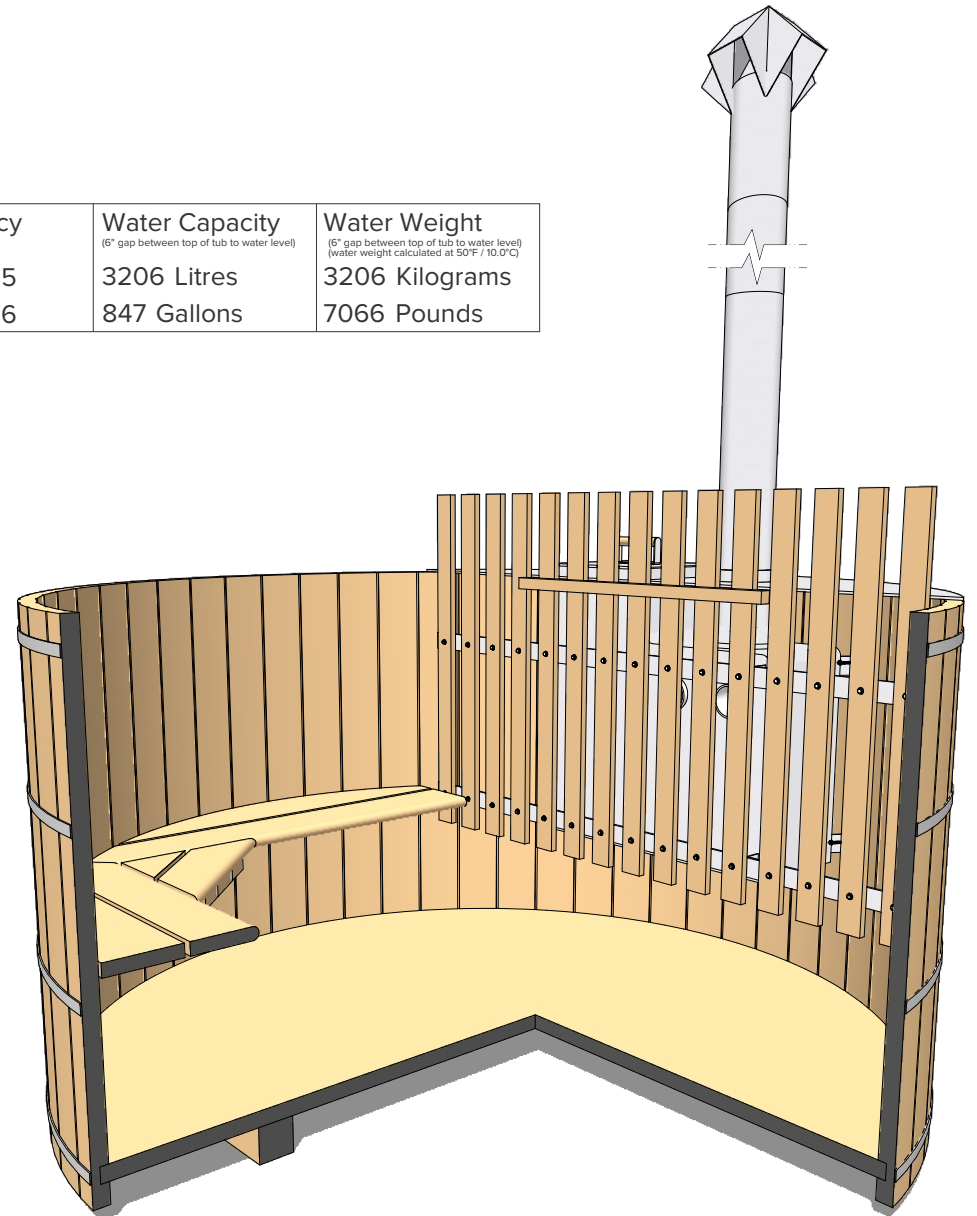
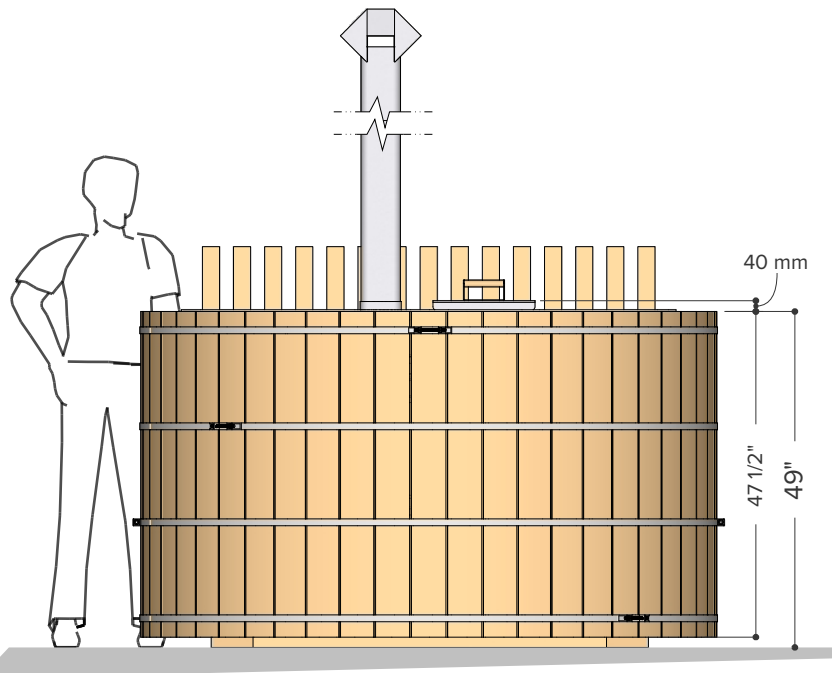

ø 84" (7')

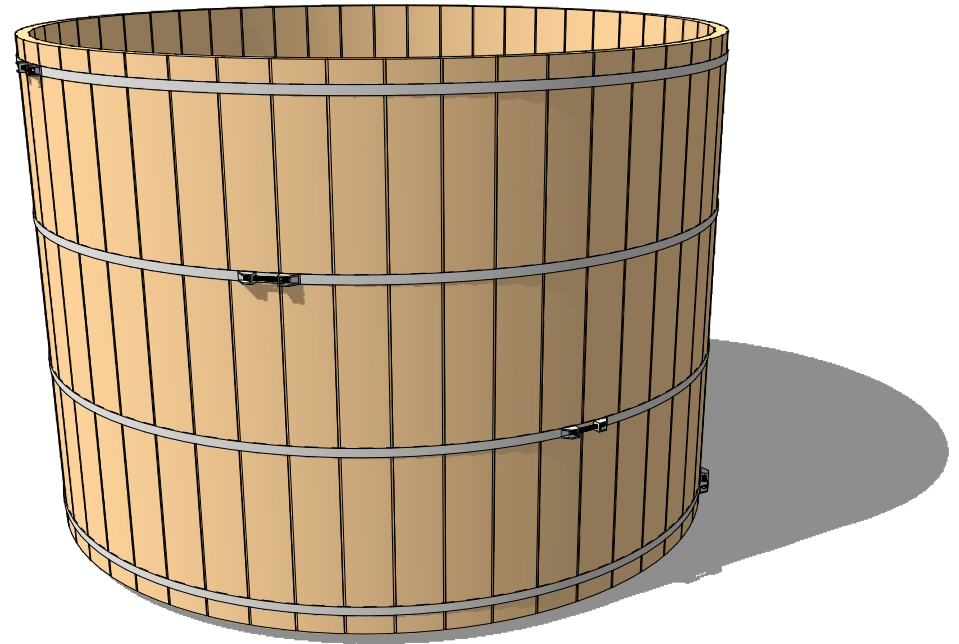
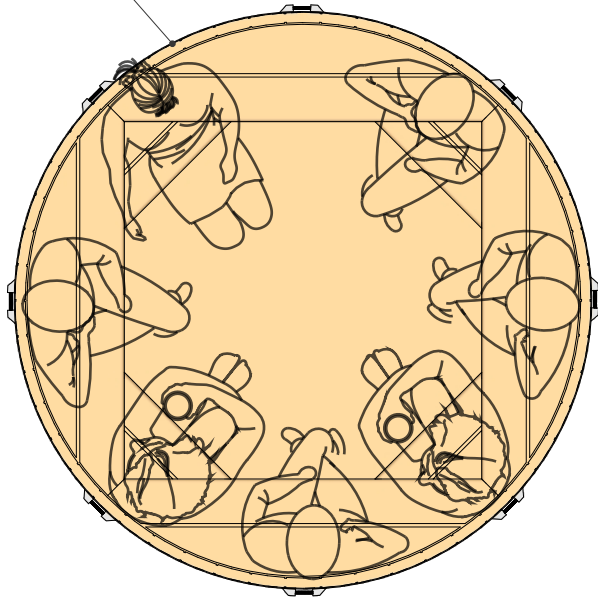

Occupancy	Water Capacity <small>(6" gap between top of tub to water level)</small>	Water Weight <small>(6" gap between top of tub to water level) (water weight calculated at 50°F / 10.0°C)</small>
Typical: 7	4219 Litres	4218 Kilograms
Max: 8	1115 Gallons	9299 Pounds

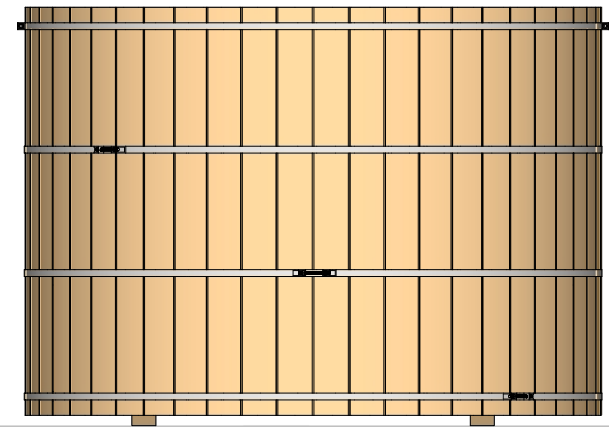
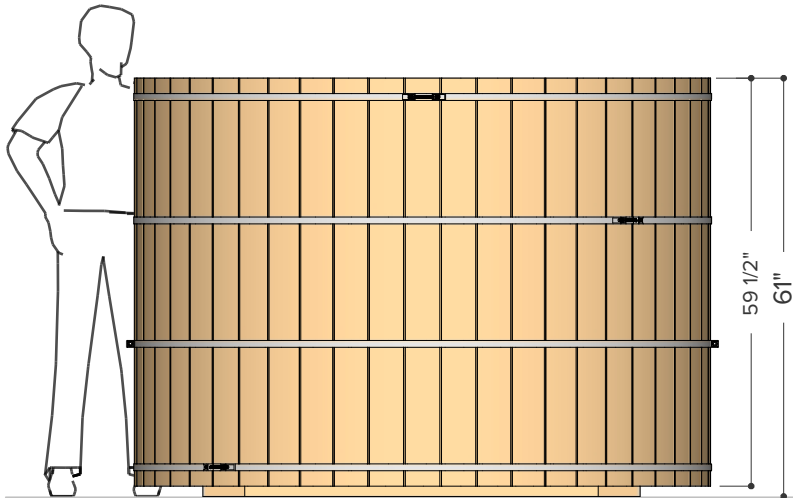

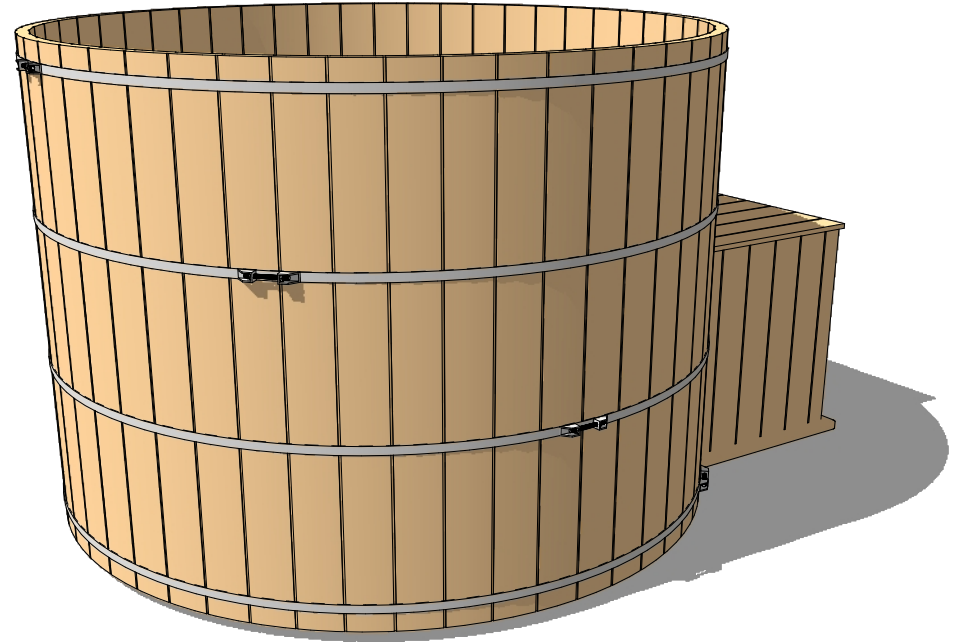
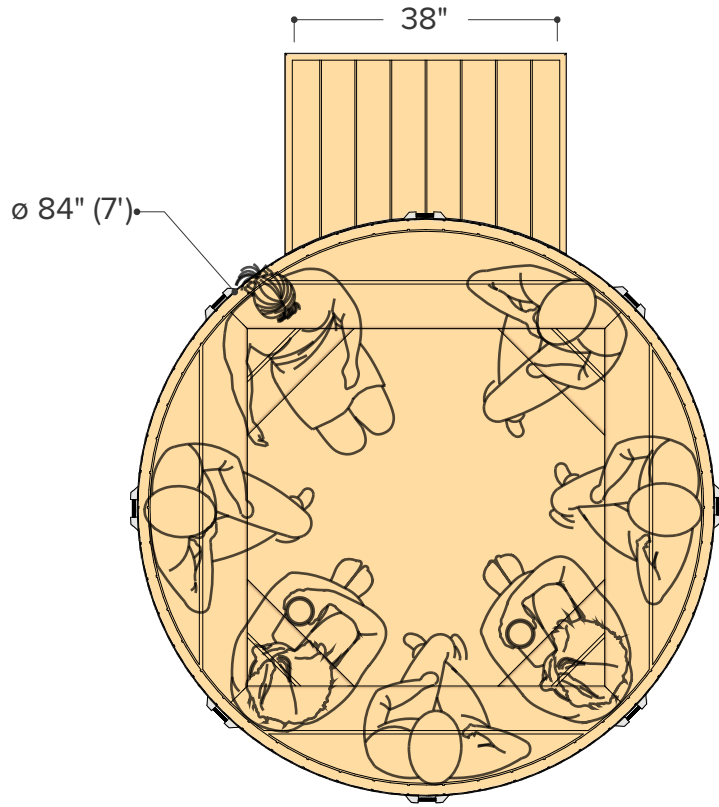

Occupancy	Water Capacity <small>(6" gap between top of tub to water level)</small>	Water Weight <small>(6" gap between top of tub to water level) (water weight calculated at 50°F / 10.0°C)</small>
Typical: 7	4219 Litres	4218 Kilograms
Max: 8	1115 Gallons	9299 Pounds

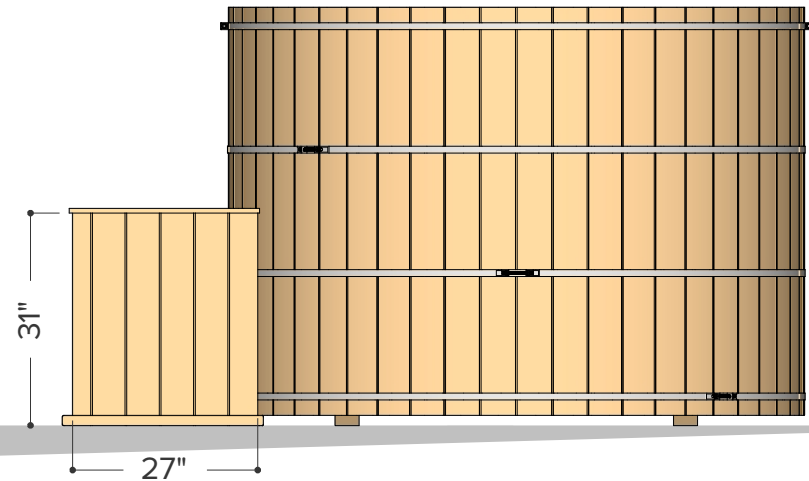
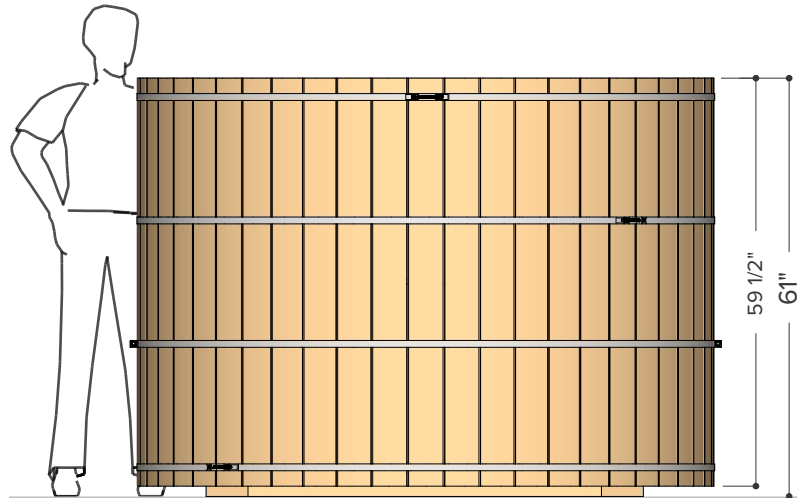

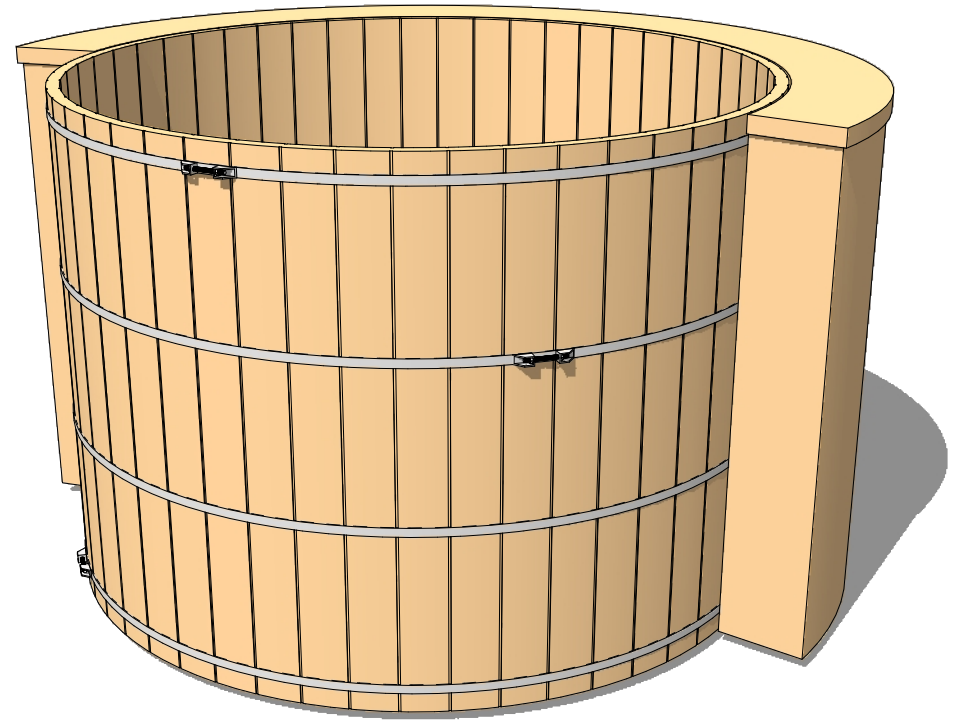
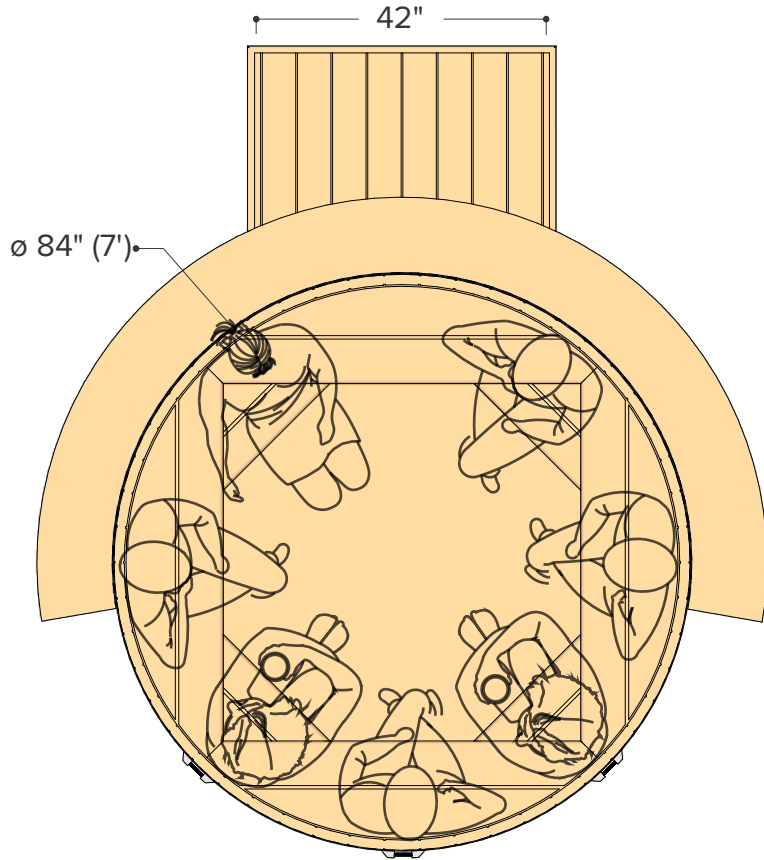

Occupancy	Water Capacity <small>(6" gap between top of tub to water level)</small>	Water Weight <small>(6" gap between top of tub to water level) (water weight calculated at 50°F / 10.0°C)</small>
Typical: 7	4219 Litres	4218 Kilograms
Max: 8	1115 Gallons	9299 Pounds

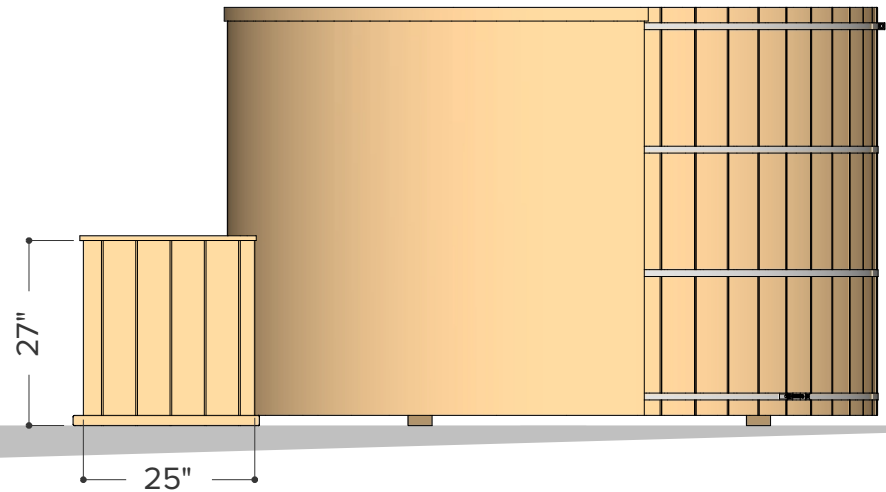
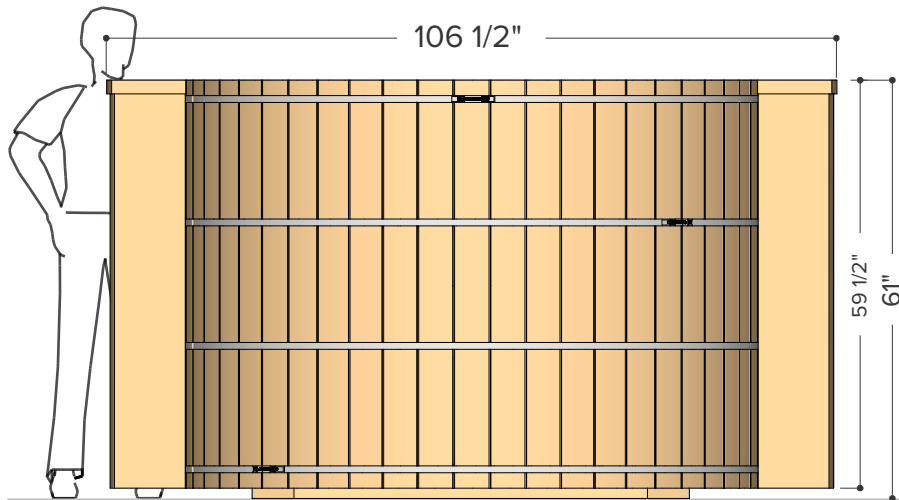

FOREST - COOPERAGE -

ø7' x 5' Tub & Multi Skirting Kit

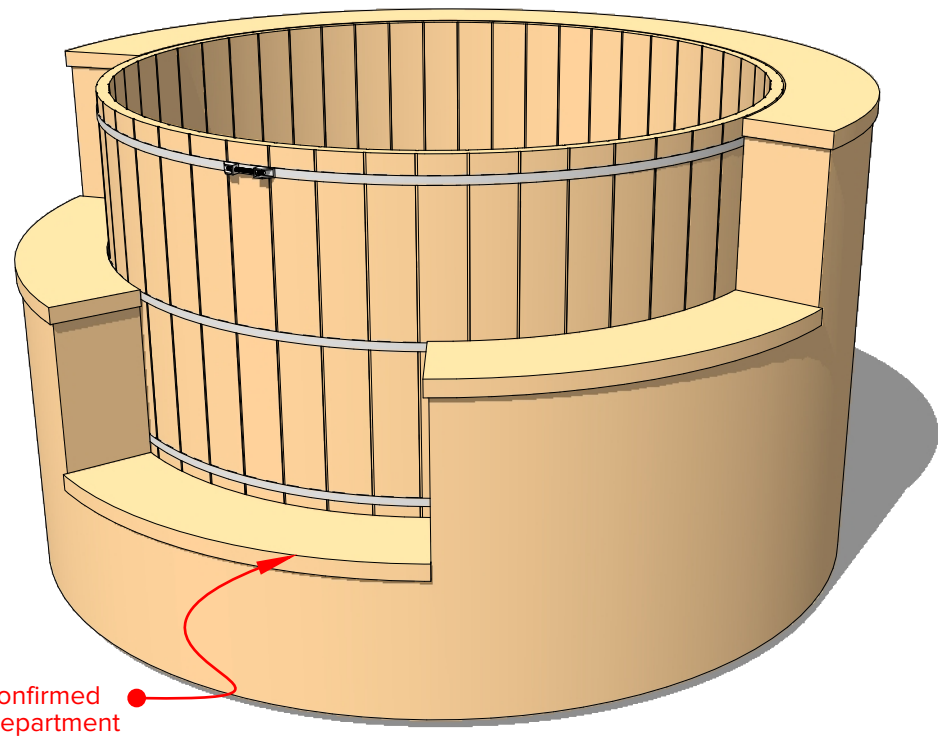
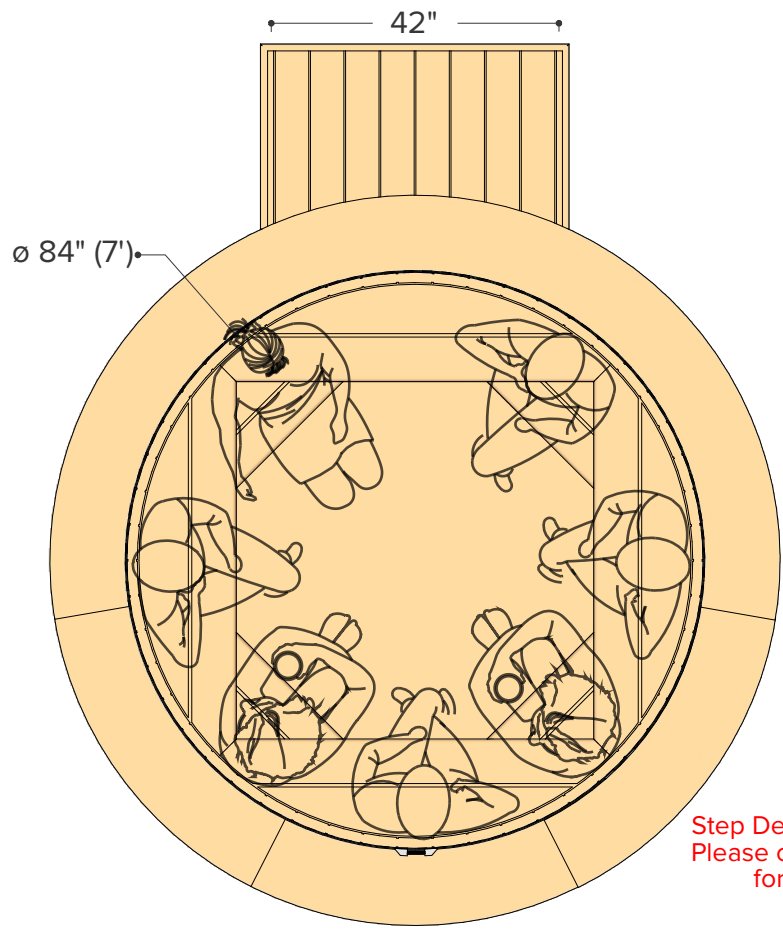

Step Designs To Be Confirmed
Please contact sales department
for further information

Occupancy	Water Capacity <small>(6" gap between top of tub to water level)</small>	Water Weight <small>(6" gap between top of tub to water level) (water weight calculated at 50°F / 10.0°C)</small>
Typical: 7	4219 Litres	4218 Kilograms
Max: 8	1115 Gallons	9299 Pounds

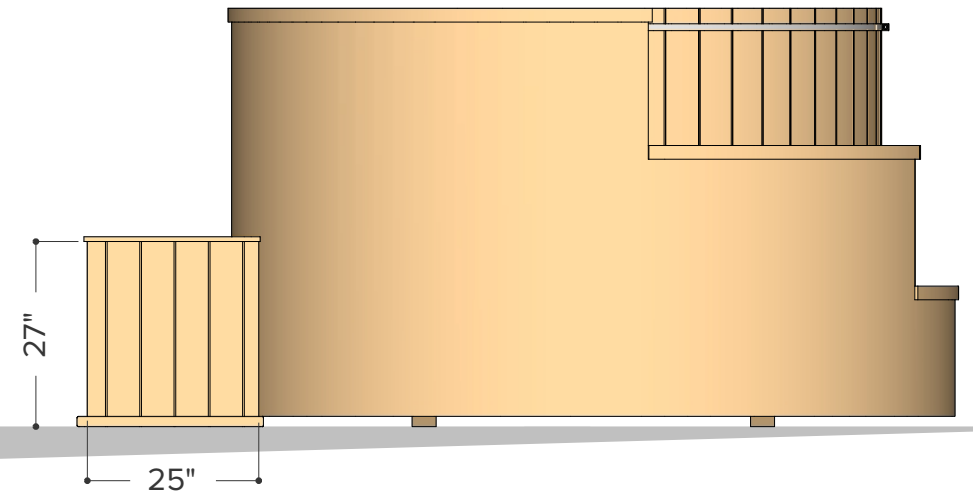
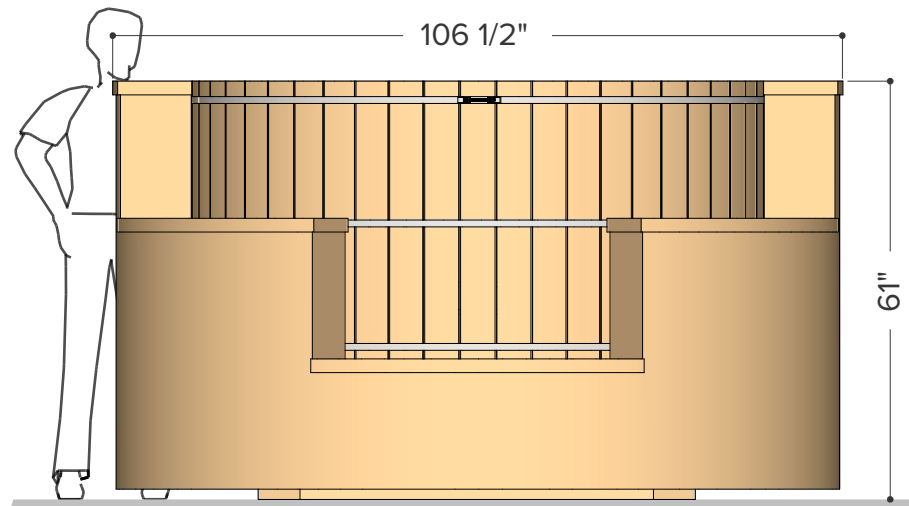

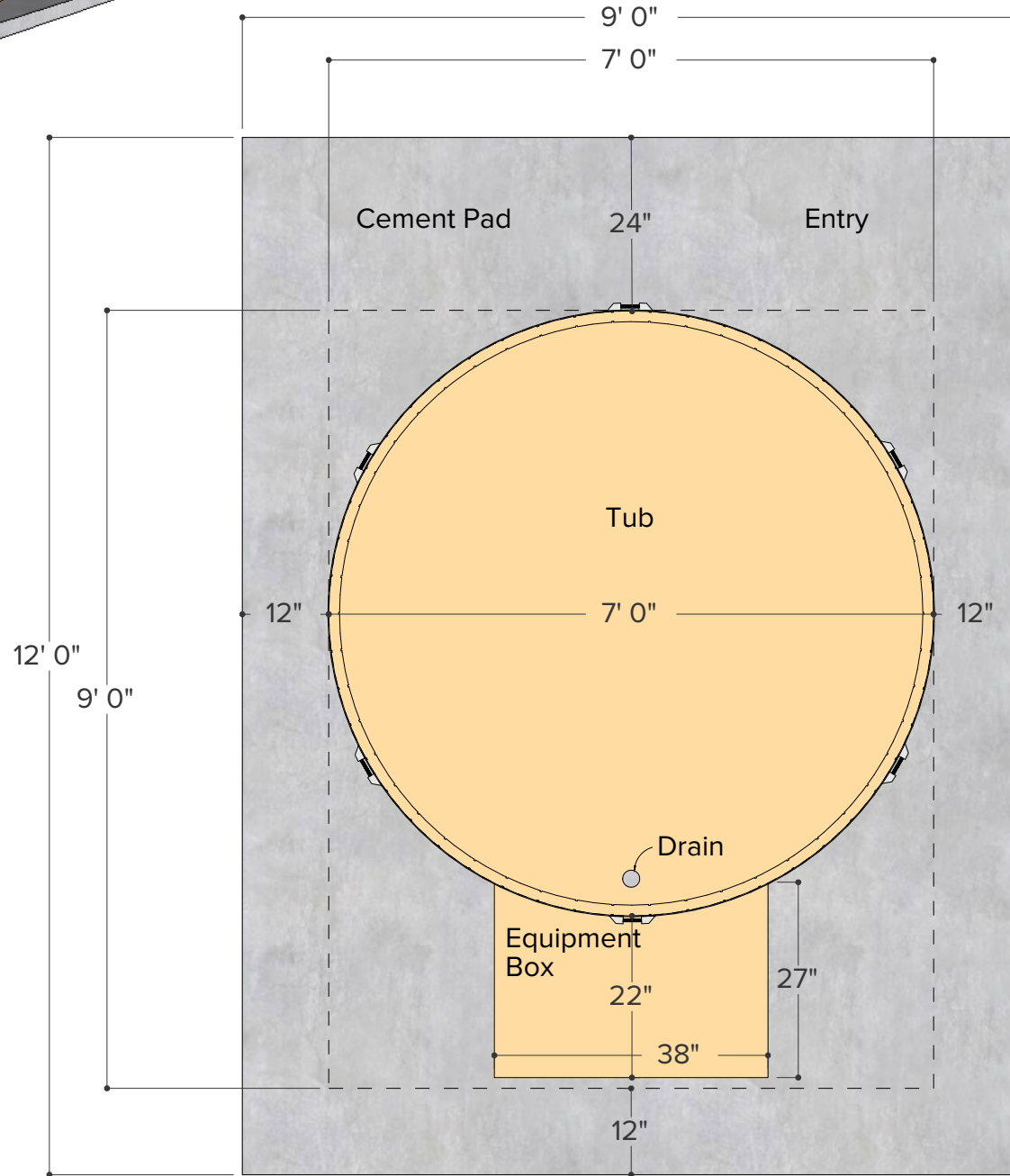
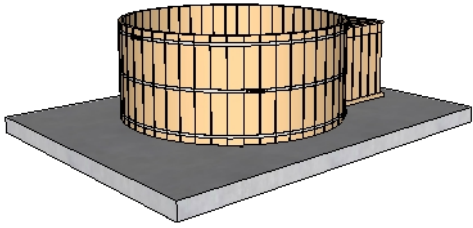

Give at least 6" Clearance from edge of pad to all parts of the tub

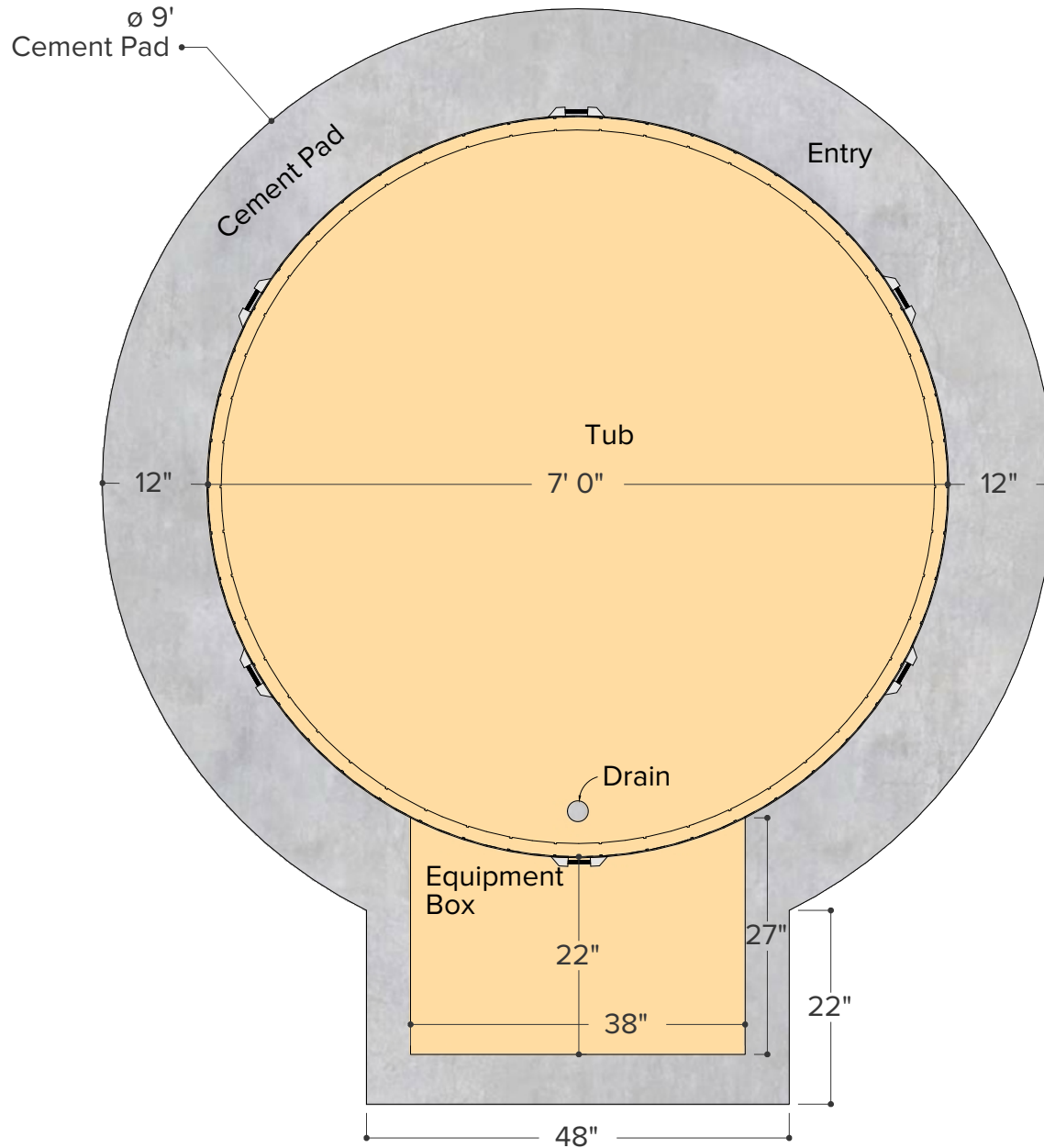
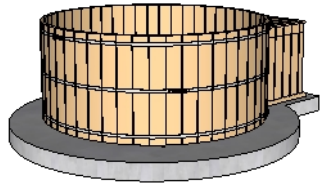

Give at least 6" Clearance from edge of pad to all parts of the tub