

Soaker Tubs / Option Index

1 Person Soaker

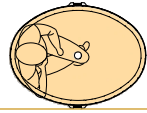

2 Person Soaker

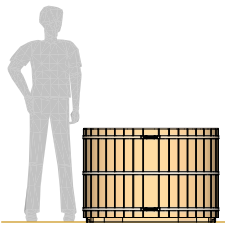
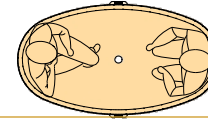
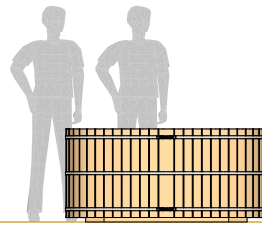

2 Person Soaker Euro Custom

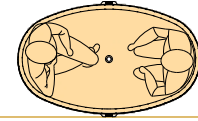

Tub

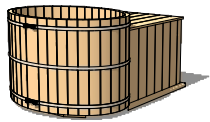

2

Tub

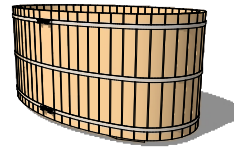

6

10

Tub & Equipment Box

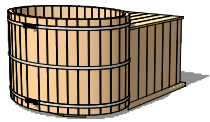

3

Tub & Equipment Box

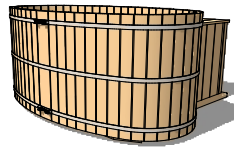

7

Equipment Box

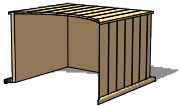

4

Equipment Box

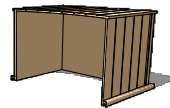

8

Foundation Plan

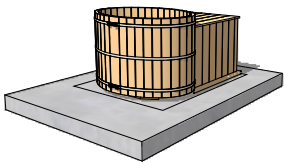

5

Foundation Plan

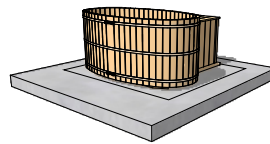

9

11

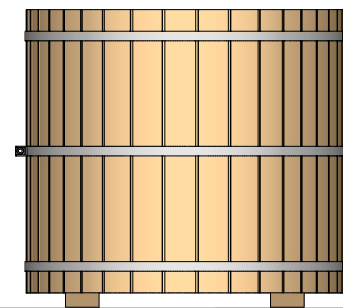
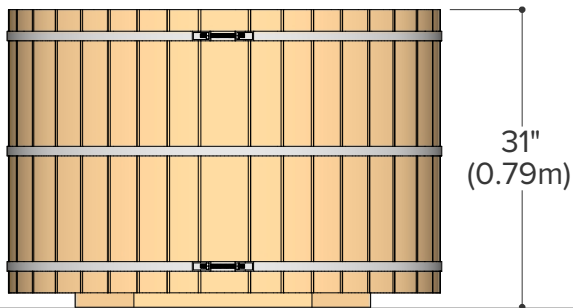
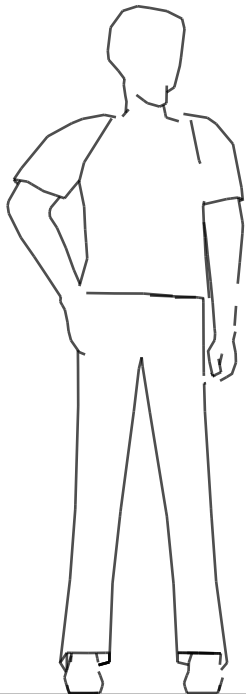
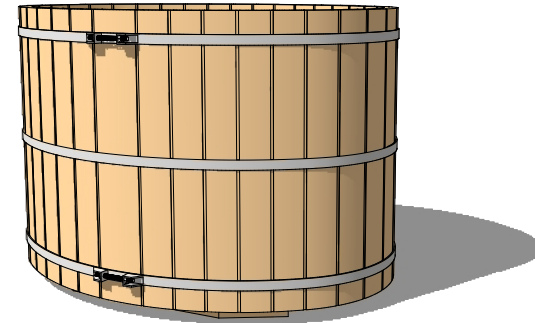
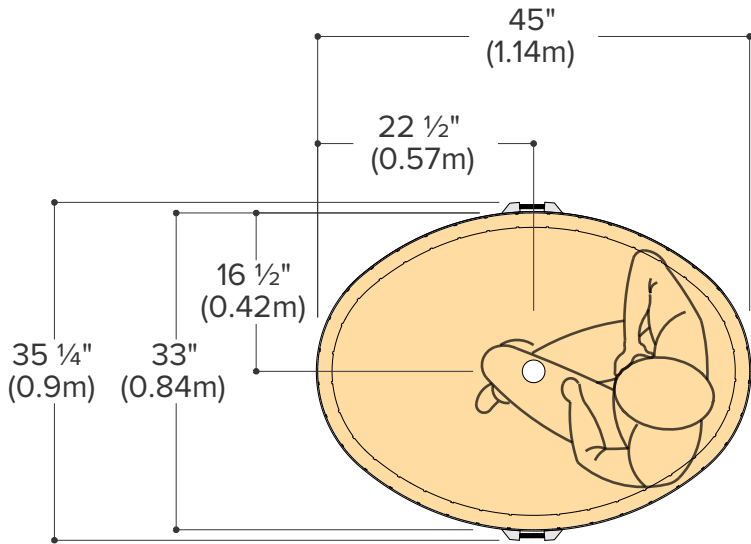

Occupancy	Water Capacity <small>(6" gap between top of tub to water level)</small>	Water Weight <small>(6" gap between top of tub to water level) (water weight calculated at 50°F / 10.0°C)</small>
Typical: 1	322 Litres (approx)	322 Kilograms (approx)
Max: 1	85 Gallons (approx)	710 Pounds (approx)

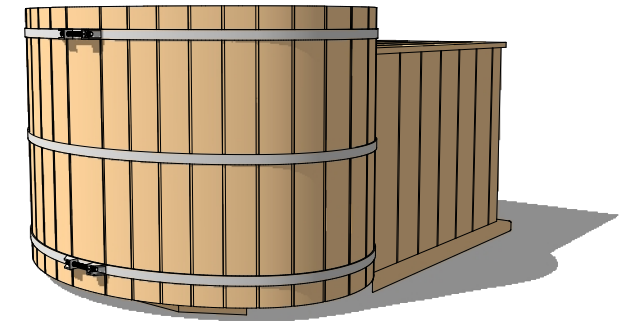
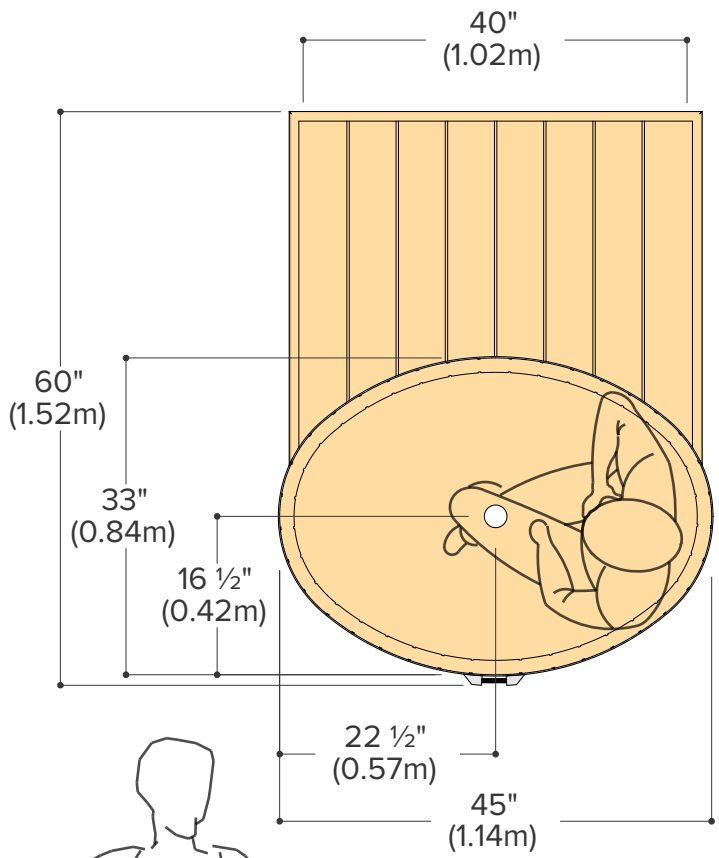

Occupancy	Water Capacity <small>(6" gap between top of tub to water level)</small>	Water Weight <small>(6" gap between top of tub to water level) (water weight calculated at 50°F / 10.0°C)</small>
Typical: 1	322 Litres (approx)	322 Kilograms (approx)
Max: 1	85 Gallons (approx)	710 Pounds (approx)

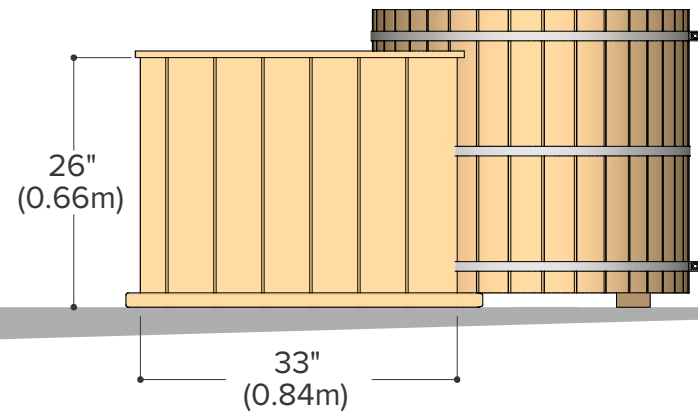
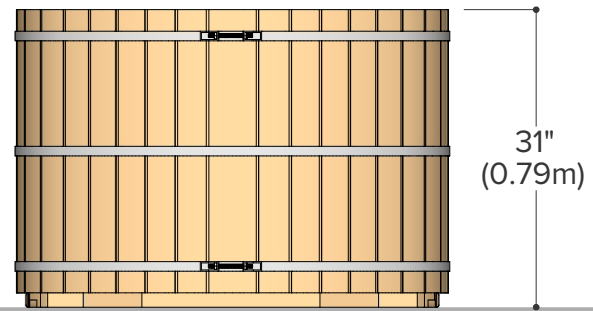

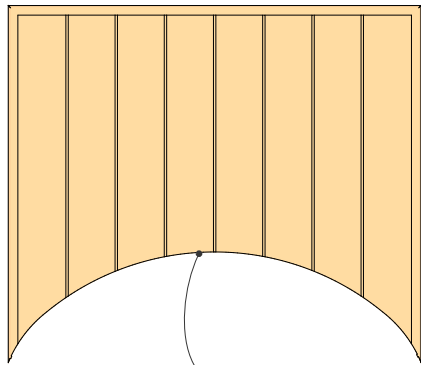

Radius to match
soaker tub

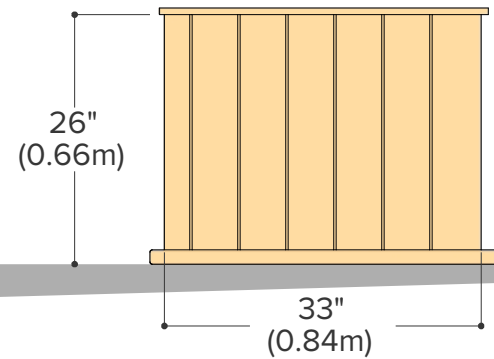
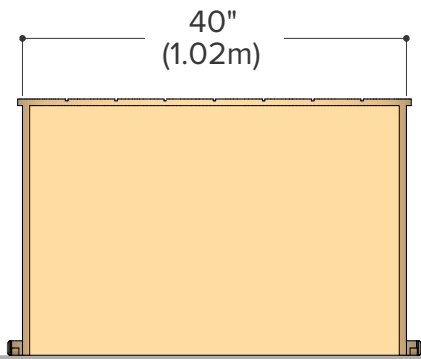
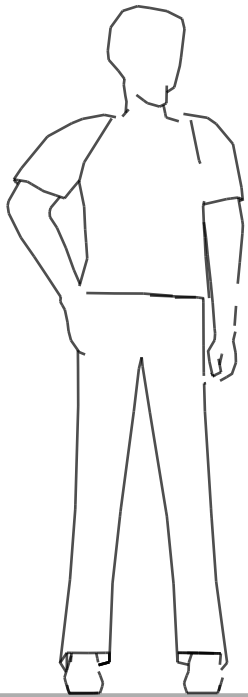
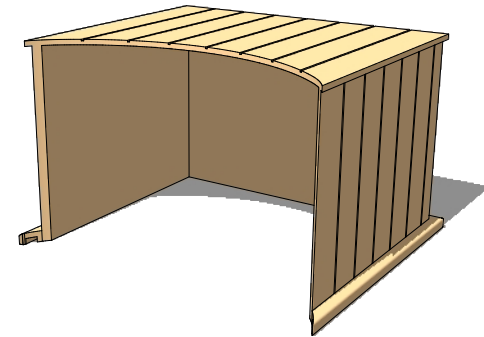

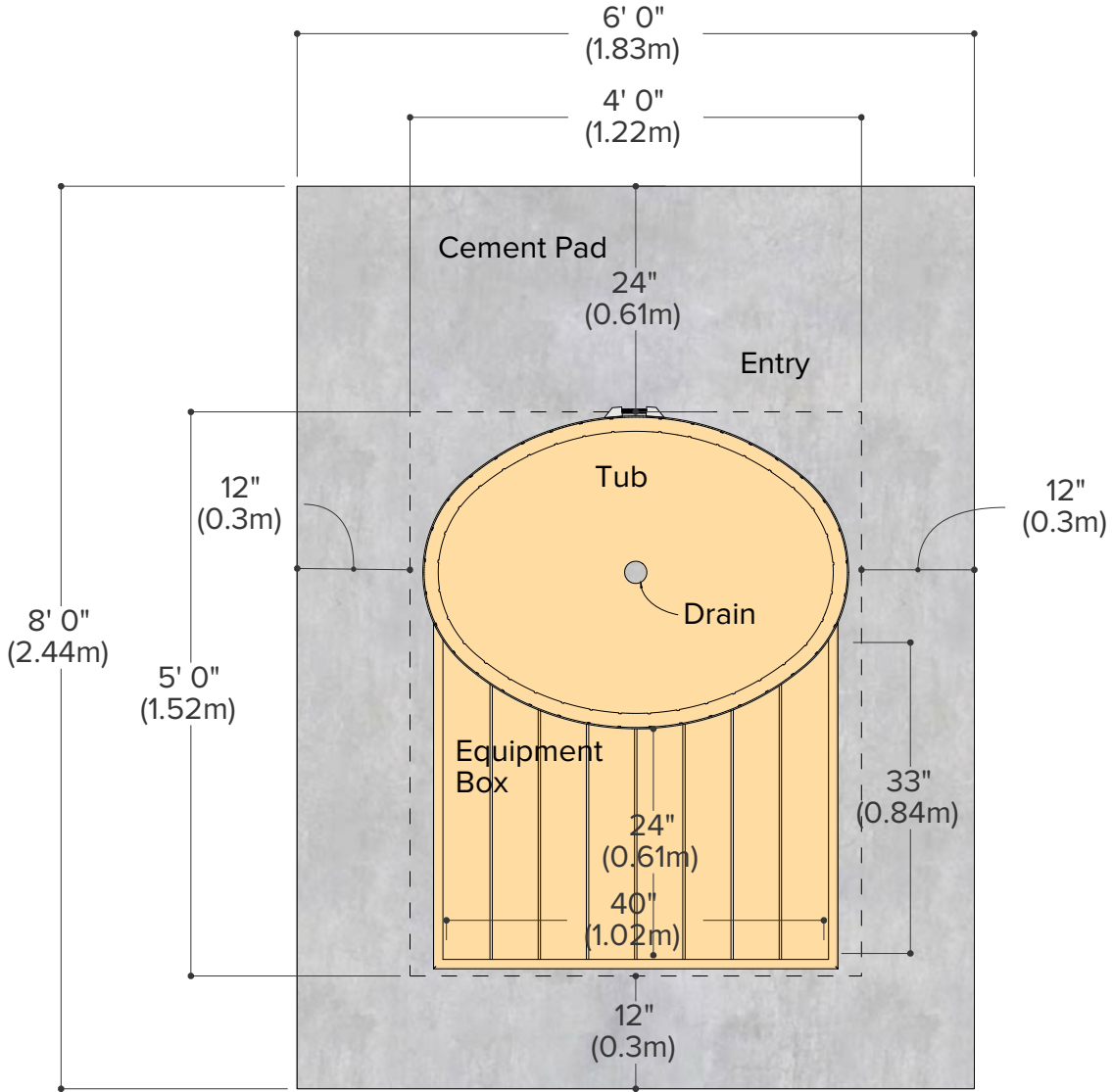
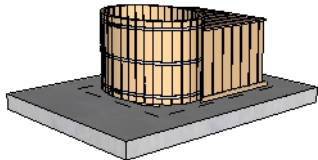

Give at least 6" Clearance
from edge of pad to all
parts of the tub

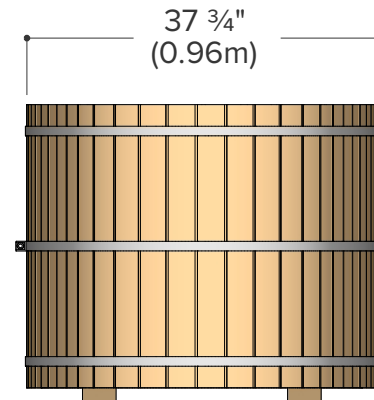
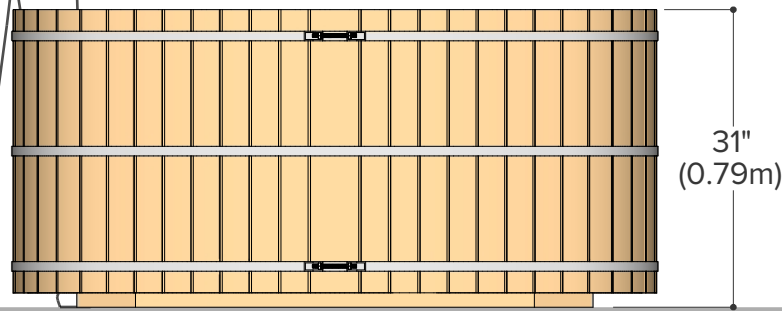
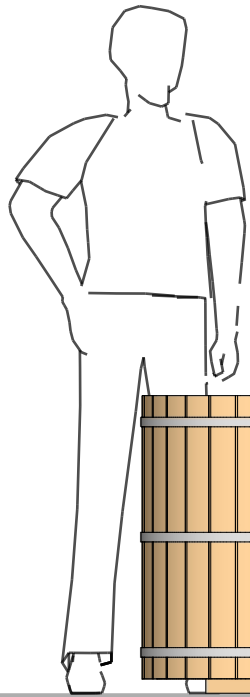
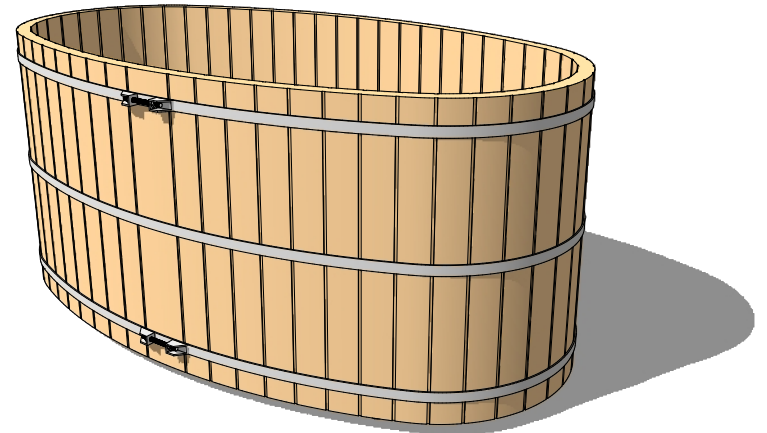
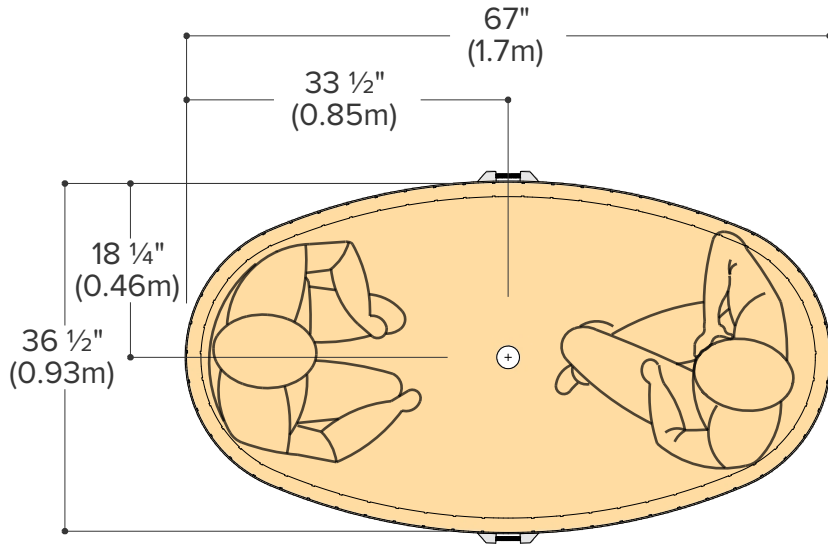

Occupancy	Water Capacity <small>(6" gap between top of tub to water level)</small>	Water Weight <small>(6" gap between top of tub to water level) (water weight calculated at 50°F / 10.0°C)</small>
Typical: 2	570 Litres (approx)	570 Kilograms (approx)
Max: 2	150 Gallons (approx)	1256 Pounds (approx)

FOREST 2 Person Soaker & Equipment Box
- COOPERAGE -

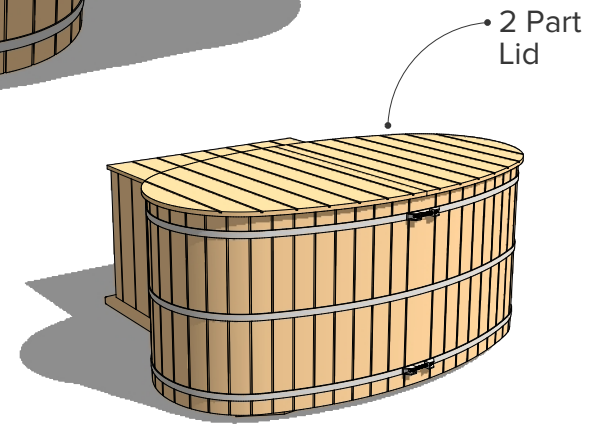
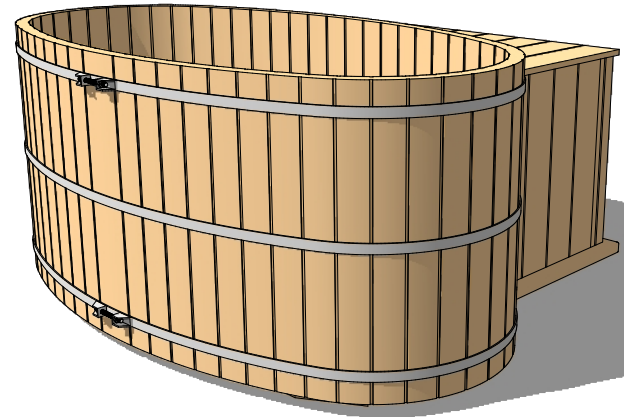
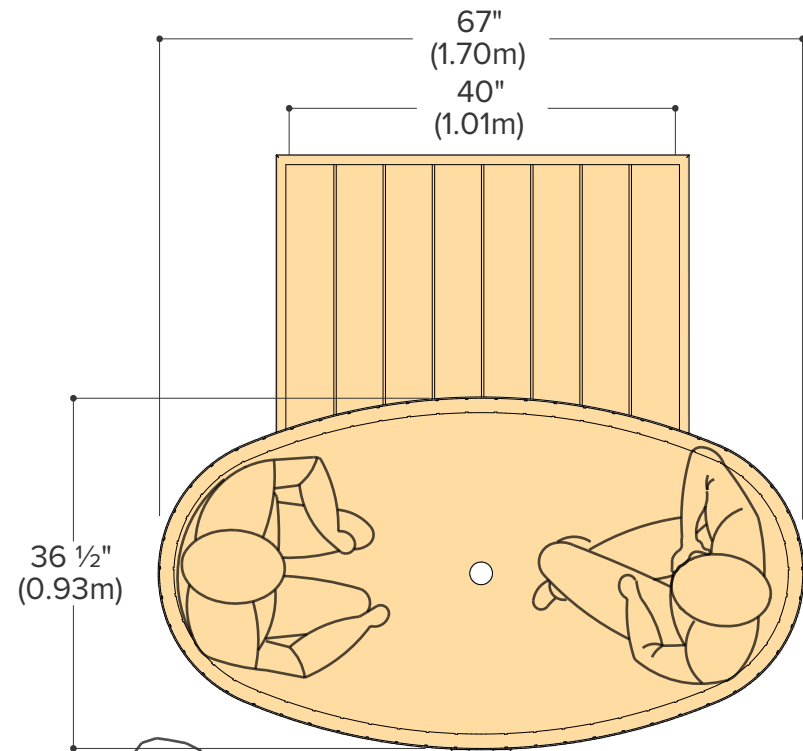

Occupancy	Water Capacity <small>(6" gap between top of tub to water level)</small>	Water Weight <small>(6" gap between top of tub to water level) (water weight calculated at 50°F / 10.0°C)</small>
Typical: 2	570 Litres <small>(approx)</small>	570 Kilograms <small>(approx)</small>
Max: 2	150 Gallons <small>(approx)</small>	1256 Pounds <small>(approx)</small>

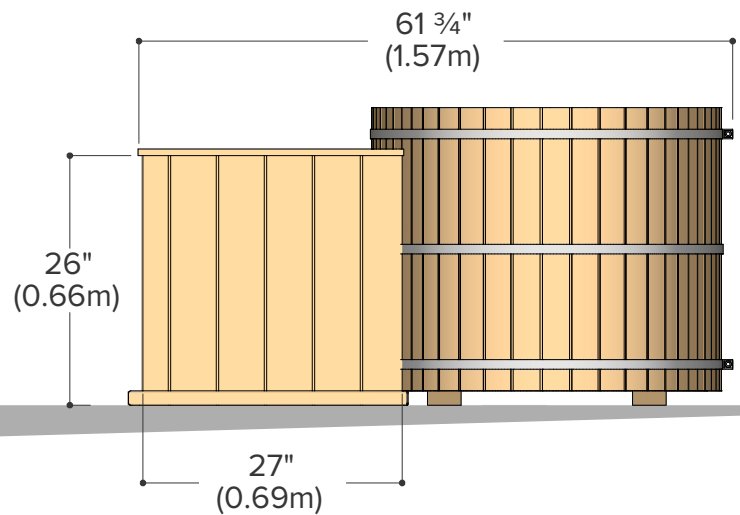
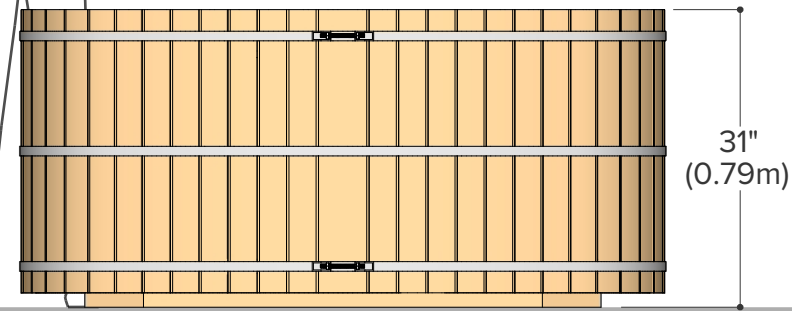
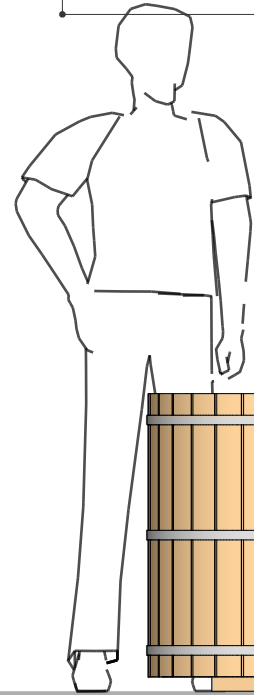

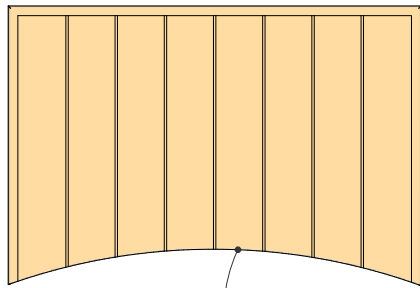

Radius to match
soaker tub

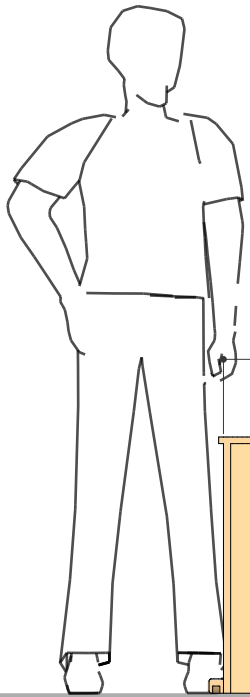
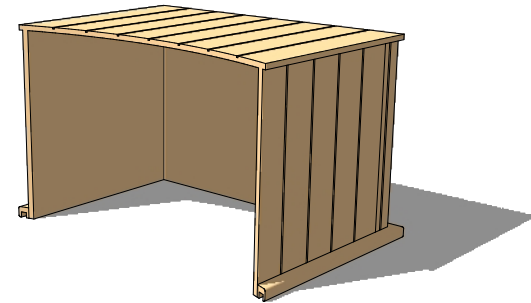

40"
(1.02m)

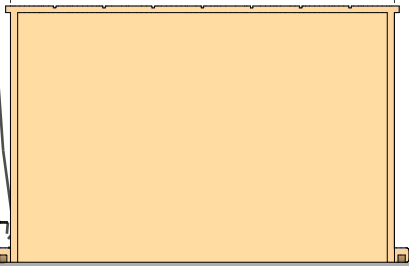

26"
(0.66m)

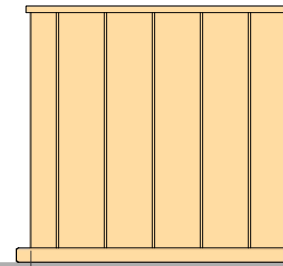

27"
(0.69m)

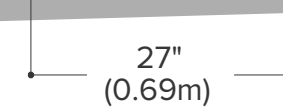

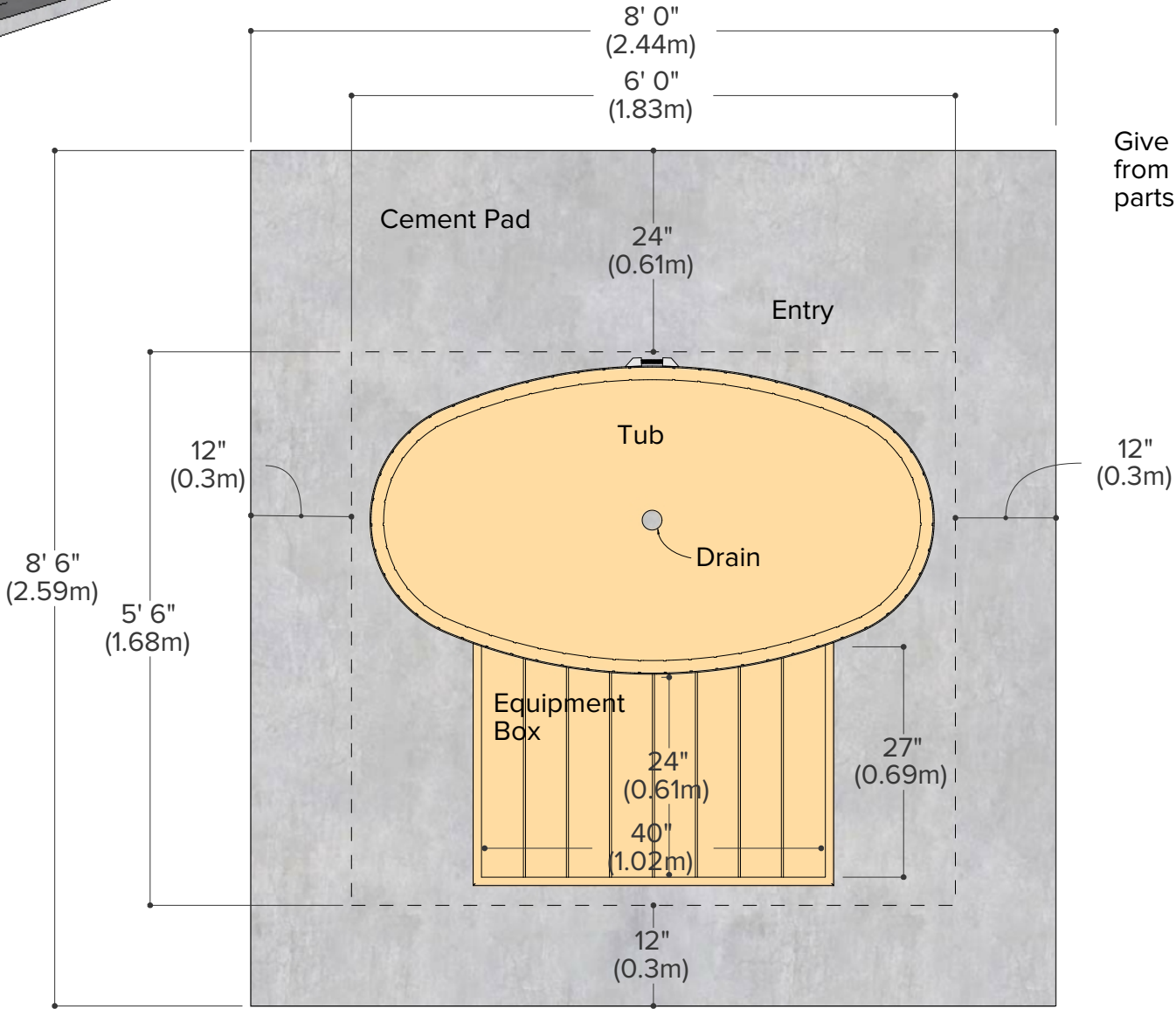
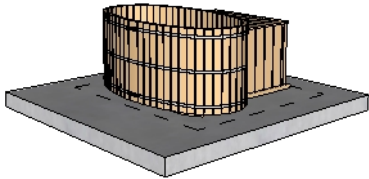

Give at least 6" Clearance from edge of pad to all parts of the tub

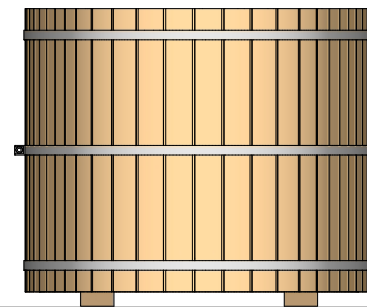
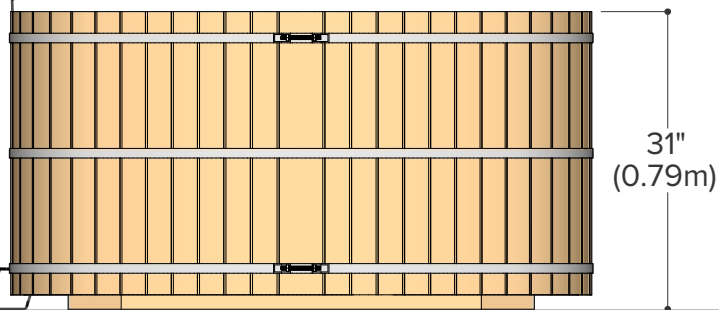
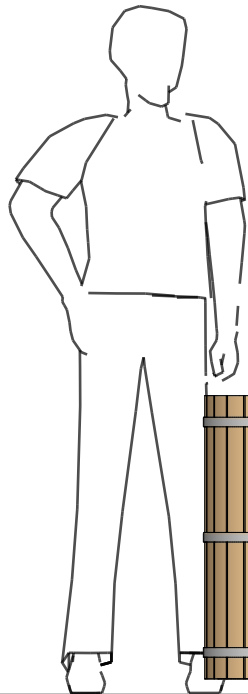
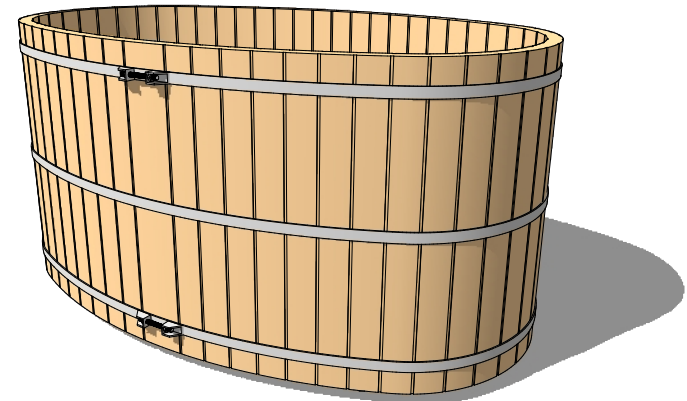
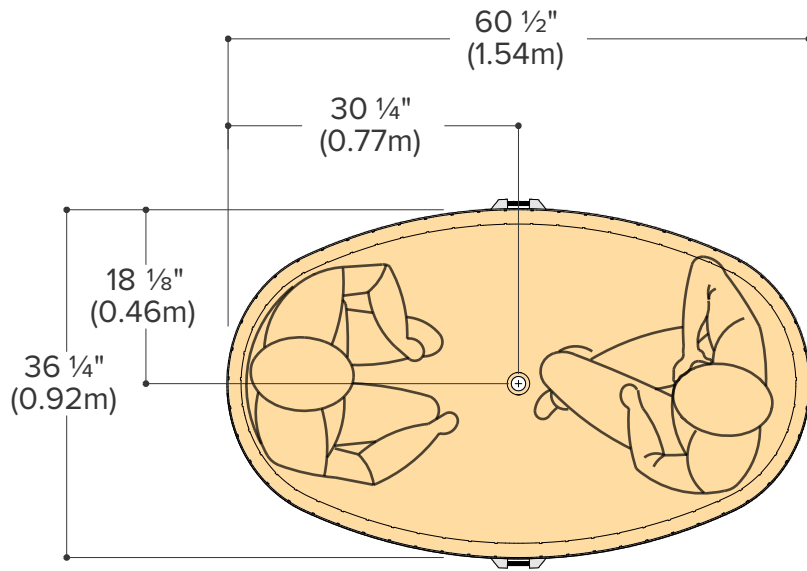

Occupancy	Water Capacity <small>(6" gap between top of tub to water level)</small>	Water Weight <small>(6" gap between top of tub to water level) (water weight calculated at 50°F / 10.0°C)</small>
Typical: 2	510 Litres <small>(approx)</small>	510 Kilograms <small>(approx)</small>
Max: 2	135 Gallons <small>(approx)</small>	1124 Pounds <small>(approx)</small>

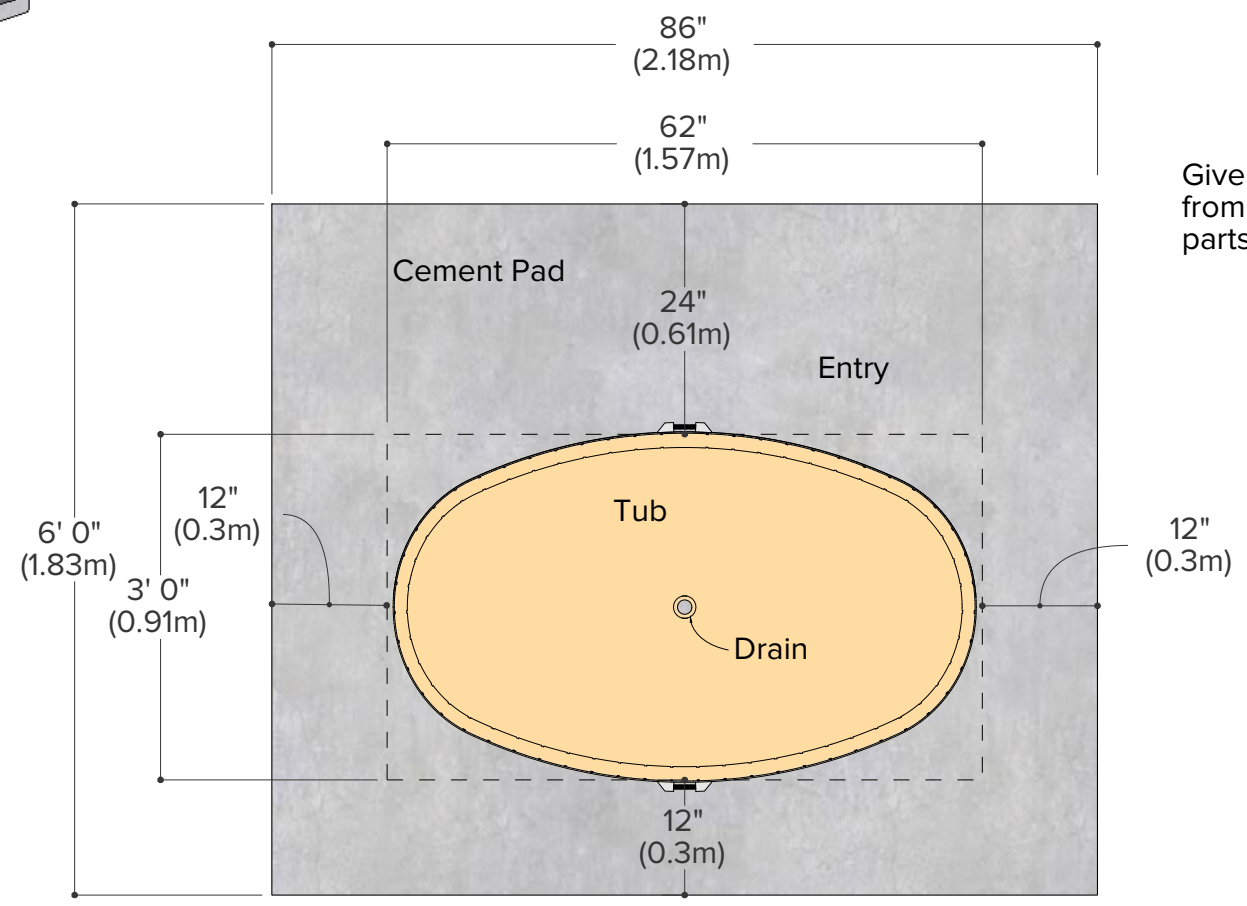
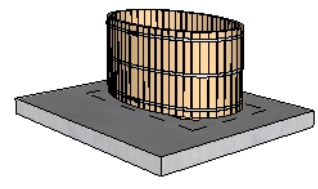

Give at least 6" Clearance
from edge of pad to all
parts of the tub